

# NOVA

Stainless Steel  
Twin Wall Flue System



**NOVA® is British built** and specifically designed to meet the requirements for multi-functional applications serving both traditional negative draught appliances or modern high efficiency condensing appliances.



Manufactured in the UK



[www.sflchimneys.com](http://www.sflchimneys.com)



Flue & Air Care  
Since 1919

## ABOUT US

Sphering is the leading industrial player in flue and chimney systems in Europe.

With +1000 experienced people across Europe, Sphering is an EU market maker with renowned expertise in design, manufacturing and distribution of advanced air and flue care systems.



  
**+1000**  
Employees

  
**8**  
Production Plants

  
**26**  
Distribution Branches

## A UNIQUE COMBINATION OF LOCAL APPROACH AND GLOBAL EFFICIENCY WE CARE TO DO WELL BY DOING GOOD

With customers



With employees

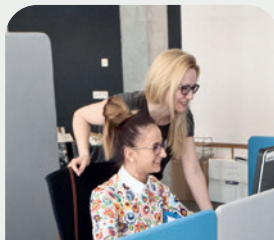

With secured and efficient product

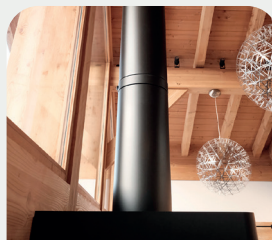

With the environment & society



EVERYTHING CHANGED IN 100 YEARS EXCEPT  
**OUR VALUES**

Staying loyal to its historical values and operating with an exclusive industrial model based on the autonomy of its brands, Sphering has become, in a century, an ethical industrial collider in Europe.

Since 1919  
**100 YEARS**  
of passion



Reliable Partner



Leading Edge



Family long-term horizon



No Shortcut

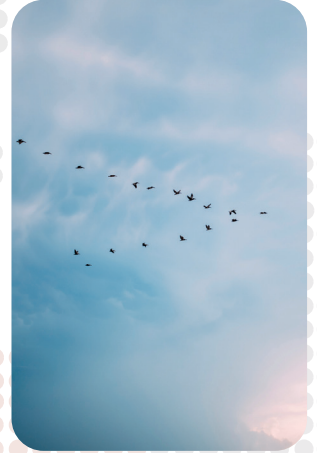

Local approach



**OUR R&D AND INNOVATION CENTERS**

We are here to stay and we collectively enable our capacity to answer our industry requirements.

**MORE THAN 150 TESTS PER YEAR**

These tests are based on requirements we have set up in order to guarantee our customers the highest levels of security and performance.



Thermal



Mechanical

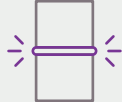

Tightness



Fine dust

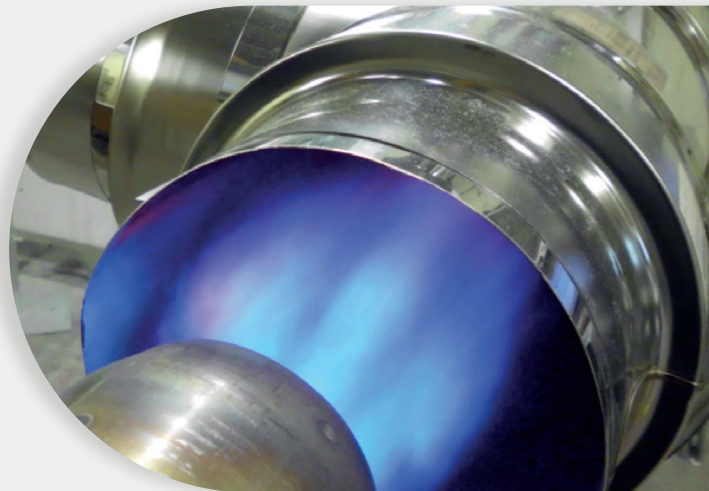

**DESIGN & TEST FOR MANUFACTURERS**

To ensure advanced safety, performance, quality and innovation.

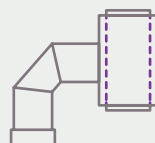

Special pieces co-development



Pairing test certification

# NOVA



Twin Wall Insulated  
Chimney System

**NOVA is a British built pre-fabricated twin-wall insulated stainless steel chimney system, CE and UKCA certified to BS EN 1856-1/2.**

**Suitable for condensing and positive pressure applications and is specifically designed to meet the demands of the latest high-efficiency heating appliances as well as traditional multi-fuel combustion equipment.**

NOVA is available in 8 internal diameters, ranging from 100mm to 355mm. With a wide range of components, together with a strong 16-barb twist-lock jointing system, NOVA offers the ultimate in ease of installation and functionality. With its strong joint design, NOVA can achieve a maximum unsupported height of 3.0 metres above the last support (2.0 m for DN100), without the need for structural locking bands.

As standard, NOVA is suitable for flue gas temperatures up to 600°C where the chimney is designed to operate under natural draught and dry conditions. With the addition of a retrofit elastomer seal, the range of application is extended, and the product is capable of positive pressure applications of up to 5000Pa(H1), subject to the performance characteristics given in Table A. This makes NOVA an ideal solution for condensing appliances and other applications where the chimney operates under positive pressure or wet condensing conditions.

Also available in a satin signal black RAL9004 architectural grade coating. Simple add a 'B' after the part number.



## Typical Applications

- Biomass
- Gas/Oil Boilers
- Micro CHP
- Pizza Ovens
- Bakery Ovens
- Coffee Roasters
- Fire Rated Compartments



British Built  
Flue System



Residential  
&  
Commercial



100-355mm  
Diameter



Twist-Lock  
Jointing System



Multi-Fuel  
Appliances



P1 / H1  
Rating



Fire Rated  
EN1366-13



Approved  
Product



Year Product Defect  
Warranty



Product &  
Downloads  
QR Code



Table A

NOVA Product Designations to BS EN 1856-1/2							
Standard Number	Diameter Range	Temperature Class	Pressure Class	D = Dry W = Wet	Corrosion Class	Material Specification Liner Grade 316L Liner Thickness 0.5	Sootfire Resistance G= Yes O= No
BS EN 1856-1	DN100 - DN355	T600	NI	D	V3	L50050	G(XX)
BS EN 1856-1	DN100-DN355	T450	NI	D	V3	L50050	G(XX)
BS EN 1856-1	DN100-DN355	T200	PI	W	V2	L50050	O(XX)
BS EN 1856-1	DN100-DN200	T160	HI	W	V2	L50050	O(XX)
BS EN 1856-2	DN100 - DN355	T450	NI	D	V3	L50050	G(XX)
BS EN 1856-2	DN100 - DN355	T200	PI	W	V2	L50050	O(XX)

**Notes**

1. PI & HI rating require elastomer seals to be fitted.
2. Distance to combustible material (XX) - DN100-DN300 = 50mm DN355 = 75mm
3. With the exception of T600 all other designations have been tested within a combustible enclosure. T600 is only rated for unenclosed application in an open environment.

**Approvals**

NOVA is CE and UKCA certified to BS EN 1856-1/2, certificate no. 0036 CPR 91455 and 0168 CPR 91455 respectively to the performance designations as detailed in Table A above.

**Fire Resistance**

NOVA has been tested to BS EN 1366-13 Fire Resistance Tests for Service Installations (Chimneys) achieving the following classification to BS EN 13501-2.

**EI 90 (i→o) h<sub>o</sub> v<sub>e</sub> Type A**

The integrity has also been assessed for a period of 4 hours under the general principles of BS 476 Part 20.

**Quality**

All components are manufactured under a Quality Management System, certificate No. FM557622, administered by British Standards in accordance with BS EN 9001:2015.

**Construction**

NOVA is fabricated with a laser welded 0.5mm 316L (1.4404:X2CrNiMo 17-12-2) stainless steel inner liner and a grade 304 (1.4301:X5CrNi18-10) outer case. The product features a high-performance insulation that is auger injected into the 25mm annulus to a density of 250Kg/m<sup>3</sup>, offering rapid stabilisation of draught and thermal performance. The unique joint design allows in inner liner to expand and contract throughout the system, eliminating the need for additional expansion components.

Condensate and pressure resistance, if the application demands, is achieved using a retrofit three lip elastomer seal located in the liner of the male end. The joint is finished with a locking band supplied as standard with the component.

**Warranty**

NOVA is backed by a comprehensive 30-year manufacturing defects warranty. The 30-year warranty is a measure of our confidence in the manufactured quality and installed reliability of our flue systems and gives added peace of mind for any installation.

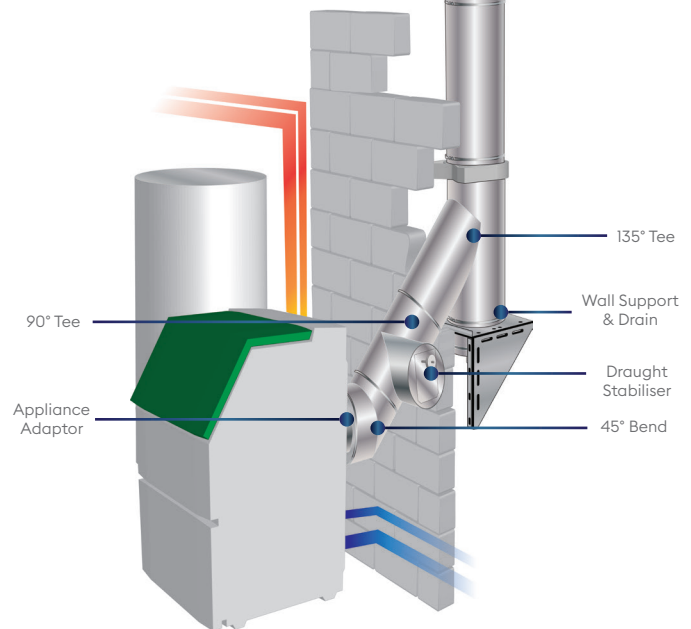
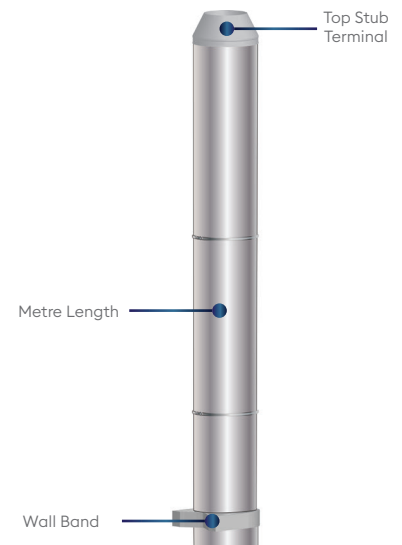

**IMPORTANT (Always Read The Installation Instructions)**  
 All installation instructions can be downloaded from our website or scan the QR code on page 23.

**Partner with us, succeed together.**

*Need assistance with your residential or commercial flue project? Our team of experienced experts is here to help at every stage. We offer product selection and design assistance, conduct system surveys, and work with key installation partners to provide bespoke turnkey packages tailored to your needs.*

# Adaptors

# NOVA

## Generic Adaptors

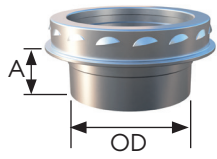

### Appliance Adaptor

Used to connect the appliance outlet to the NOVA chimney system. This adaptor is also used for connection of the draught regulator to the branch of a 90° tee.

ø	Dim A	OD	Code
100mm	63	98	4578504N
130mm	63	128	4578505N
150mm	63	148	4578506N
180mm	63	178	4578507N
200mm	63	198	4578508N
250mm	63	248	4578510N
304mm	63	298	4578512N
355mm	63	348	4578514N

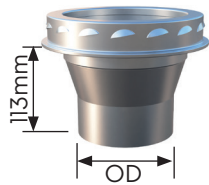

### Appliance Increaser Adaptor

Used to increase the appliance outlet size by one diameter.

ø	OD	Code
100mm	80mm	4579404N
150mm	123mm	4579505N
150mm	130mm	4579405N

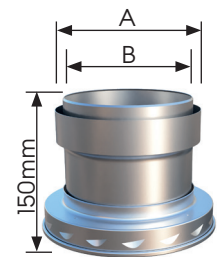

### NOVA to Flex Adaptor

Used to connect the NOVA product to a generic flexible flue liner. Not suitable for SELFLEX.

ø	A	B	Code
100mm	113	96	4573404N
130mm	136	121	4573405N
150mm	163	146	4573406N
180mm	193	171	4573407N
200mm	213	196	4573408N
250mm	263	246	4573410N
304mm	313	296	4573412N
355mm	370	346	4573414N

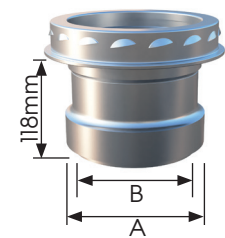

### Flex to NOVA Adaptor

Used to connect a generic flexible flue liner to NOVA, e.g. where a masonry chimney has been capped within a roof void. Not suitable for SELFLEX.

ø	A	B	Code
100mm	113	96	4573204N
130mm	136	121	4573205N
150mm	163	146	4573206N
180mm	190	171	4573207N
200mm	213	196	4573208N
250mm	263	246	4573210N
304mm	313	296	4573212N
355mm	370	346	4573214N

## Product Adaptors

### NOVA to SUPRA PLUS Adaptor

Designed to facilitate connection from the NOVA to SUPRA PLUS chimney system.

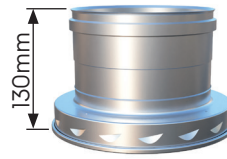

ø	Code
100mm	4179710
130mm	4179713
150mm	4179715
180mm	4179718
200mm	4179720
250mm	4179725
304mm	4179730
355mm	4179735

### SUPRA PLUS to NOVA Adaptor

Used to connect from the SUPRA PLUS chimney system or for use as an appliance adaptor.

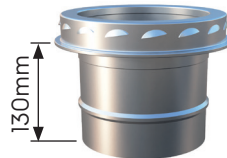

ø	Code
100mm	4179610
130mm	4179613
150mm	4179615
180mm	4179618
200mm	4179620
250mm	4179625
304mm	4179630
355mm	4179635

### SVIT to NOVA Tapered Adaptor

Used to connect from a SVIT connecting flue pipe to Nova. 50mm long tail.

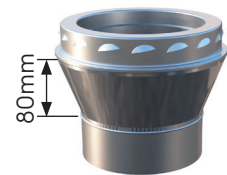

ø	Code
100mm	-
130mm	4571805N
150mm	4571806N
180mm	-
200mm	-

For other sizes, please speak to Customer Services.

### SVIT to NOVA Tapered Increasing Adaptor

Used to connect from a SVIT connecting flue pipe to Nova. 50mm long tail.

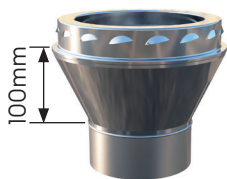

ø	A	Code
130mm	100	4572105
150mm	125	4572106

## NOVA to SELFLEX Adaptor

Screwed adaptor to connect NOVA to the SELFLEX flexible liner system.



ø	A	Code
130mm	68	0593312
150mm	68	0593315

## SELFLEX to NOVA Adaptor

Screwed adaptor to connect the SELFLEX flexible liner system to NOVA.

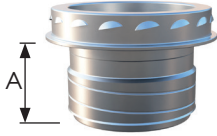

ø	A	Code
130mm	65	0593912
150mm	65	0593915

## SELFLEX Push-Fit Adaptors

Adaptor to facilitate connection from NOVA to SELFLEX and vice versa. Supplied complete with EasyFit Clamp.

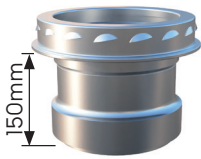
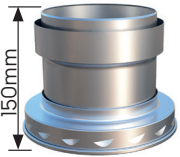

ø	NOVA → SELFLEX	SELFLEX → NOVA
100mm	4573504N	4573804N
130mm	4573505N	4573805N
150mm	4573506N	4573806N
180mm	4573507N	4573807N
200mm	4573508N	4573808N
250mm	4573510N	4573810N

## Stove Adaptors

### Short Tail Stove Adaptors

Specifically designed for connecting Nova to stove outlets.

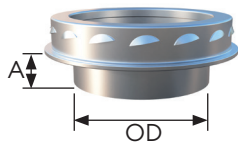

ø	A	OD	Code
130mm	36	123	4578205N
150mm	36	148	4578206N

### Long Tail Stove Adaptors

Specifically designed for connecting Nova to stove outlets.

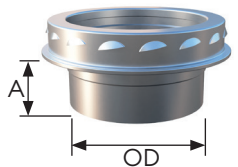

ø	A	OD	Code
130mm	60	123	4578305N
150mm	60	148	4578306N

### Short Tail Increasing Stove Adaptor

Use to increase the flue size of a smaller appliance outlet spigot.

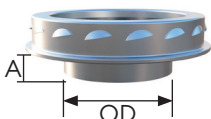

ø	A	OD	Code
130mm	30	123	4579205N
150mm	30	148	4579206N

## Long Tail Increasing Stove Adaptor

Used to increase by one size in respect to the appliance outlet spigot.

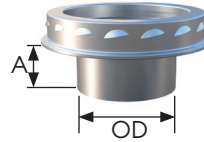

ø	A	OD	Code
130mm	60	123	4579305N
150mm	60	148	4579306N

## Starter Lengths

### Long Tapered Adaptor Length

Offers an aesthetic transition from a single wall connecting flue pipe to twin wall.



ø	OD	Code
130mm	123	4570405N
150mm	148	4570406N
180mm	173	4570407N
200mm	198	4570408N

*NOTE: This component MUST only be fitted to the connecting flue pipe and not directly to the appliance outlet spigot.*

### Short Tapered Adaptor Length

Offers an aesthetic transition from a single wall connecting flue pipe to twin wall.

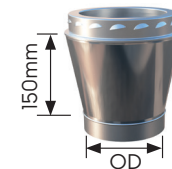

ø	OD	Code
130mm	123	4570505N
150mm	150	4570506N
180mm	178	4570507N
200mm	200	4570508N

*NOTE: This component MUST only be fitted to the connecting flue pipe and not directly to the appliance outlet spigot.*

### EasyFit Starter Length

Used for direct connection to the appliance offering a very aesthetic finish. Supplied with M10 test point.

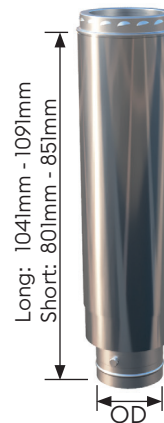

ø	OD	Long Code
130mm	123	4571205N
150mm	148	4571206N

ø	OD	Short Code
130mm	123	4571305N
150mm	148	4571306N

### EasyFit Starter Length - Paint Temperature Application

**Low Temperature (LT)** - These are designed for use on 5kW Ecodesign wood burning stoves where the flue gas temperature does not exceed 350°C and the top of the stove does not exceed 230°C.

**High Temperature (HT)** - These are used for all other appliances where the temperature limits could potentially exceed that of the LT version. The HT version uses a high temperature silicone based coating on the skirt, suitable for withstanding temperature up to 600°C. Due to the different chemistry of the LT and HT coatings, there is a slight variation in colour and texture. For painted version add either LT or HT after the part number.

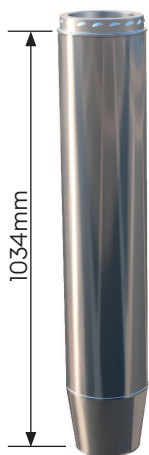

## SVIT / SIGMA 1MM to Nova Sliding Adaptor

Used to connect SVIT or SIGMA 1mm connecting flue pipe to NOVA. This is designed to allow the connecting flue pipe to slide inside the component to a maximum engagement of up to 200mm), allowing easy disconnection of the appliance while also offering adjustment within the system.

### SVIT

Ø	Code
130mm	4573205N
150mm	4573206N

### SIGMA 1MM

Ø	Code
130mm	4580005
150mm	4580006

## Lengths



### Straight Lengths

Available in nominal installed lengths of 120mm, 250mm, 500mm and 1000mm.

Ø	Installed Length			
	120mm Code	250mm Code	500mm Code	1000mm Code
100mm	4575304N	4571904N	4575104N	4575004N
130mm	4575305N	4571905N	4575105N	4575005N
150mm	4575306N	4571906N	4575106N	4575006N
180mm	4575307N	4571907N	4575107N	4575007N
200mm	4575308N	4571908N	4575108N	4575008N
250mm	4575310N	4571910N	4575110N	4575010N
304mm	4575312N	4571912N	4575112N	4575012N
355mm	4575314N	4571914N	4575114N	4575014N

Ø	1500mm Length	Code
150mm	1500mm Length	4579906N

### Adjustable Lengths

The adjustable length offers a degree of flexibility when standard length dimensions are not suitable. All adjustable lengths are supplied with separate insulating material for insertion into the annulus once the installed length has been determined. Where adjustable lengths are required for positive pressure and condensate resistance, two seals are required per component. Sizes 130mm and 150mm are supplied complete with an EasyFit Clamp Band, removing the need to drill and self-tap the two telescopic sections together.

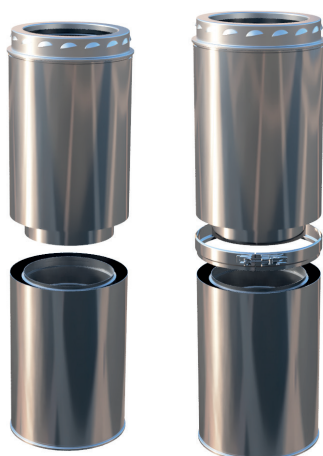

Sizes:  
100, 180, 200, 250, 304, 355

Sizes:  
130, 150

Ø	Short 210mm-317mm	Long 310mm-517mm	Extra Long 500mm-890mm	Seals Req.
100mm	4576604N	4574604N	N/A	2X 4006310
130mm	4576605N	4574605N	4576205N	2X 4006313
150mm	4576606N	4574606N	4576206N	2X 4006315
180mm	4576607N	4574607N	N/A	2X 4006318
200mm	4576608N	4574608N	N/A	2X 4006320
250mm	4576610N	4574610N	N/A	2X 4006325

Ø	Short (255mm - 410mm)	Long (330mm - 550mm)	1X Seal	1X Seal
304mm	4576612N	4574612N	4006530	4006430
355mm	4576614N	4574614N	4006535	4006435

Note: As the insulation density is installed on site and not controlled by SFL, it is recommend that this component is located at least 300mm from any combustible material as a safety measure. Adjustable lengths when used on condensing (WET) application require two seals fitted.

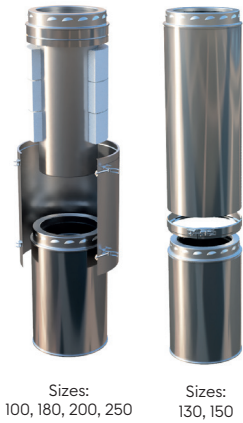

## Adjustable Slip Section

The adjustable slip section is designed to be used with an existing length and allows a smaller range of adjustment. Sizes 100, 180, 200 and 250 use a cover jacket, while sizes 130 and 150 use an EastFit clamp Band. For adjustment range see page 23.

∅	Code
100mm	4570004N
130mm	4577105N
150mm	4577106N
180mm	4570007N
200mm	4570008N
250mm	4570010N

## Inspection Length P1\W

Used to provide access for inspection and cleaning. For use on positive pressure and condensing appliances. Suitable for flue gas temperatures up to 200°C at 200Pa positive pressure. Where used on higher temperature NI applications, the inner seal MUST be removed.

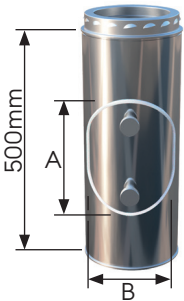

∅	A	B	Code
100mm	206	70	4576304N
130mm	206	80	4576305N
150mm	215	100	4576306N
180mm	215	100	4576307N
200mm	215	100	4576308N
250mm	215	100	4576310N
304mm	215	100	4576312N
355mm	215	100	4576314N

## M16 Probe Length P1/W

Supplied with a M16 Hex Screw to facilitate a commissioning sampling probe. A 100mm wide removable cover jacket is supplied to cover the sampling point when not in use. For applications greater than T200 and where operating under natural draught (NI) conditions, remove the rubber washer.



∅	Code
100mm	4576704N
130mm	4576705N
150mm	4576706N
180mm	4576707N
200mm	4576708N
250mm	4576710N
304mm	4576712N
355mm	4576914N

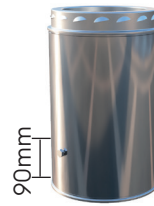

## M10 Probe Length (NI/D)

Supplied with an M10 hex screw sampling point. Installed Length 300mm

∅	Code
130mm	457XX05N
150mm	457XX06N

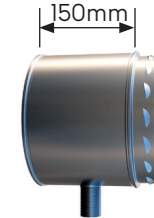

## Duct Drain Length

Used in an inclined position to trap condensate and permit drainage back through the system. Connection is via a stainless steel 1" BSP external threaded connection and incorporates an internal back flow dam.

∅	Code
100mm	4576804N
130mm	4576805N
150mm	4576806N
180mm	4576807N
200mm	4576808N
250mm	4576810N
304mm	4576812N
355mm	4576814N

## Damper Length (P1/W)

Use for balancing multi-inlet systems or to add additional resistance to a flue. Also suitable for use on wood burning stoves.

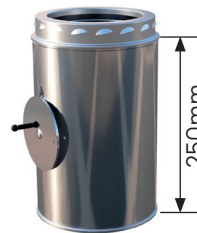

∅	Code
100mm	4574004N
130mm	4574005N
150mm	4574006N
180mm	4574007N
200mm	4574008N
250mm	4574010N
304mm	4574012N
355mm	4574014N

## 2 Segment Elbows (15°, 30°, 40°, 45°)

Provides a change of direction, measured from the vertical by the specified angle. Elbows are supplied with an unbarbed female coupler to allow full 360° rotation and a screw-toggle type locking band for additional strength. For dimension please refer to page 22.

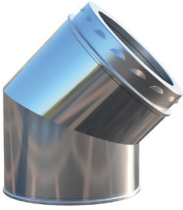

Ø	Code			
	15° Code	30° Code	40° Code	45° Code
100mm	4575404N	4575504N	4575604N	4575704N
130mm	4575405N	4575505N	4575605N	4575705N
150mm	4575406N	4575506N	4575606N	4575706N
180mm	4575407N	4575507N	4575607N	4575707N
200mm	4575408N	4575508N	4575608N	4575708N
250mm	4575410N	4575510N	4575610N	4575710N
304mm	4575412N	4575512N	4575612N	4575712N
355mm	4575414N	4575514N	4575614N	4575714N

## Three-segment 90°, 85° & 87° Elbows

Provides a change of direction measured from the vertical. Both 85 and 87 Elbows can be used to provide either a 3°, or preferably a 5° fall within the system to allow drainage of condensation through the system. The 90° Elbow is also offered with an inspection / access door.

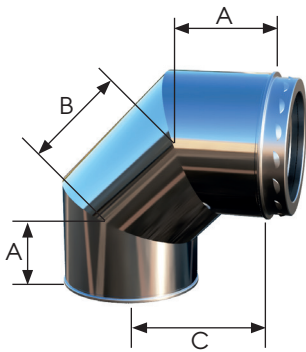

85°, 87° & 90° Elbows

Ø	Dimension (mm)			85°	Dimension (mm)			87°
	A	B	C	Code	A	B	C	Code
100mm	91	126	192	4575804N	91	126	185	4574904N
130mm	98	136	207	4575805N	98	136	200	4574905N
150mm	102	144	217	4575806N	102	144	210	4574906N
180mm	108	156	233	4575807N	108	156	226	4574907N
200mm	112	165	244	4575808N	112	165	236	4574908N
250mm	123	185	270	4575810N	123	185	262	4574910N
304mm	132	217	297	4575812N	132	217	291	4574912N
355mm	140	235	318	4575814N	140	235	312	4574914N

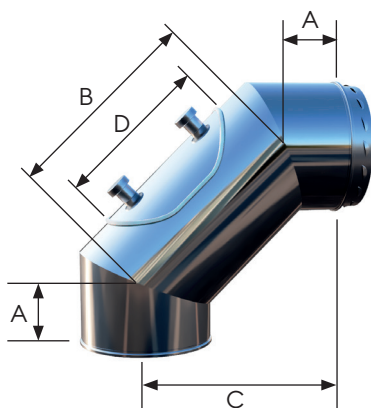

90° Inspection Elbow

Ø	Dimension (mm)			90°	Inspection Elbow				90°
	A	B	C	Code	A	B	C	D	Code
100mm	91	126	180	4575904N	91	272	283	180	4576104N
130mm	98	136	193	4575905N	98	272	290	180	4576105N
150mm	102	144	204	4575906N	102	282	301	200	4576106N
180mm	108	156	219	4575907N	108	282	307	200	4576107N
200mm	112	165	229	4575908N	112	282	311	200	4576108N
250mm	123	185	254	4575910N	123	282	322	200	4576110N
304mm	132	217	285	4575912N	133	282	332	200	4576112N
355mm	140	235	306	4575914N	143	282	342	200	4576114N

The Inspection Elbow is suitable for T200 PI W applications. For high temperatures and where used on negative (NI) system, the Inner Seal MUST be removed.

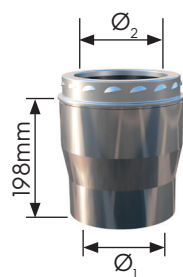

## Increaser

Facilitates an increase in a diameter. Constructed with a smooth conical design and welded construction to prevent the build-up of condensates.

Ø <sub>1</sub>	Ø <sub>2</sub>	Code
100mm	130mm	4573604N
100mm	150mm	4573705N
130mm	150mm	4573605N
150mm	180mm	4573606N
150mm	200mm	4573706N
180mm	200mm	4573607N
200mm	250mm	4573608N

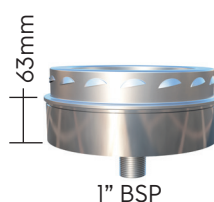

## Condensate Collector

Used at the bottom of a vertical chimney to facilitate the drainage of condensate from the system. Fitted with a stainless steel BSP external thread drain connection. Supplied with BSP cap protector.

Ø	Code
100mm	4576904N
130mm	4576905N
150mm	4576906N
180mm	4576907N
200mm	4576908N
250mm	4576910N
304mm	4576912N
355mm	4576914N

## Eccentric Increaser

Designed specifically for condensing applications to provide an increase in diameter without pooling of condensation in horizontal or inclined runs.

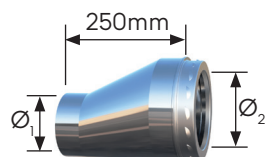

Ø <sub>1</sub>	Ø <sub>2</sub>	Code
150mm	200mm	4570606N
180mm	250mm	4570607N
200mm	250mm	4570608N
200mm	304mm	4570708N
250mm	304mm	4570610N
250mm	355mm	4570710N

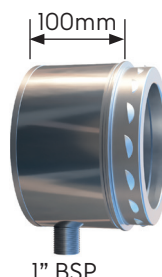

## Condensate Collector with Side Drain

Mainly used on the end of an inclined header to condensing appliances to facilitate drainage through the system. Fitted with a stainless steel BSP external thread drain connection. Supplied with BSP cap protector.

Ø	Code
100mm	4577204SS
130mm	4577205SS
150mm	4577206SS
180mm	4577207SS
200mm	4577208SS
250mm	4577210SS
304mm	4577212SS
355mm	4577214SS

# Tee Components

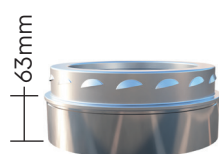

## Locking Plug

Used to close off the branch or base of a tee or for use as an access/inspection component.

Ø	Code
100mm	4579104N
130mm	4579105N
150mm	4579106N
180mm	4579107N
200mm	4579108N
250mm	4579110N
304mm	4579112N
355mm	4579114N

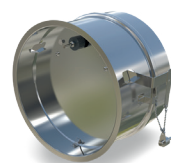

## Draught Regulator

Dual action barometric draught regulator suitable for multi fuel negative (NI) draught applications. Designed to be used with SFL chimney systems where excessive draught is likely to create combustion problems. When used with the NOVA chimney system, the regulator should be applied with the 45785XXN appliance adaptor (in turn located onto the 90° tee branch). Installed length 125mm.

Ø	Code
100mm	3192004
130mm	3192005
150mm	3192006
180mm	3192007
200mm	3192008
250mm	3192010
304mm	3192012
355mm	3192014

*Note: The above draught regulator is not suitable for explosion relief. Please contact SFL for alternative models.*

## 90°, 93° & 95° Equal Tee

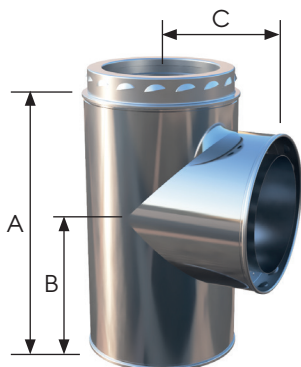

## Equal Tees

Equal tees are available in 90°, 93° and 95° options. Mainly used at the base of a vertical chimney to allow drainage, manifold headers, or inspection points. The 93° and 95° options are mainly used in condensing systems to allow either a 3° or 5° fall, allowing condensation to drainage back through the system to a suitable drainage point.

Ø	Dimensions			Standard Tees - Code		
	A	B	C	90° Code	93° Code	95° Code
100mm	300	180	140	4573004N	4573304N	4576404N
130mm	330	195	155	4573005N	4573305N	4576405N
150mm	350	205	165	4573006N	4573306N	4576406N
180mm	380	220	180	4573007N	4573307N	4576407N
200mm	400	230	190	4573008N	4573308N	4576408N
250mm	450	255	215	4573010N	4573310N	4576410N
304mm	500	265	240	4573012N	4573312N	4576412N
355mm	550	305	270	4573014N	4573314N	4576414N

## 90° & 95° Reducing Tee

A wide variety of reducing tee combinations are available. Listed below are the most common single-step reductions, i.e. 150mm body, 130mm branch. For a full range of available reducing tees and made to order specials, please speak to SFL Technical Sales.

## 90° & 95° Reducing Tees

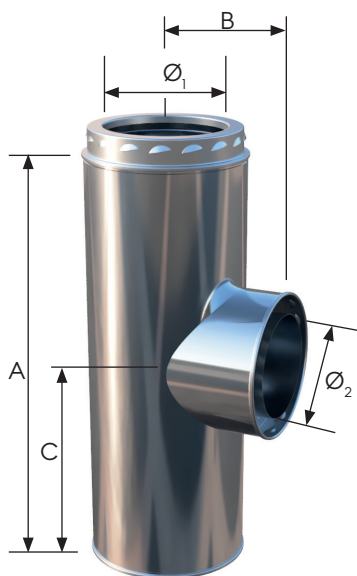

Ø <sub>1</sub>	Ø <sub>2</sub>	Dimensions				Code	
		A	B	C 90°	C 95°	90° Reducing Tee	95° Reducing Tee
130mm	100	533	148	266.5	287	4559001	4559501
150mm	100	533	158	266.5	287	4559002	4559502
150mm	130	533	158	266.5	287	4559003	4559503
180mm	100	533	173	266.5	287	4559009	4559509
180mm	130	533	173	266.5	287	4559011	4559511
180mm	150	533	173	266.5	287	4559013	4559513
200mm	100	533	183	266.5	287	4559015	4559515
200mm	130	533	183	266.5	287	4559017	4559517
200mm	150	533	183	266.5	287	4559019	4559519
200mm	180	533	183	266.5	287	4559021	4559521
250mm	100	533	208	266.5	287	4559023	4559523
250mm	130	533	208	266.5	287	4559025	4559525
250mm	150	533	208	266.5	287	4559026	4559526
250mm	180	533	208	266.5	287	4559027	4559527
250mm	200	533	208	266.5	287	4559028	4559528
300mm	100	533	233	266.5	287	4559029	4559529
300mm	130	533	233	266.5	287	4559030	4559530
300mm	150	533	233	266.5	287	4559031	4559531
300mm	180	533	233	266.5	287	4559032	4559532
300mm	200	533	233	266.5	287	4559033	4559533
300mm	250	533	233	266.5	287	4559034	4559534
350mm	100	533	258	266.5	287	4559035	4559535
350mm	130	533	258	266.5	287	4559036	4559536
350mm	150	533	258	266.5	287	4559037	4559537
350mm	180	533	258	266.5	287	4559038	4559538
350mm	200	533	258	266.5	287	4559039	4559539
350mm	250	533	258	266.5	287	4559040	4559540
350mm	300	533	258	266.5	287	4559041	4559541

## 35° Tee (P/W)

Used at the base of a vertical chimney, or to allow a smooth transition from the horizontal to vertical plain when used with a 45° elbow. The coupler on the branch is unbarbed to allow unlimited rotational adjustment and provided with an adjustable screw-toggle locking band.

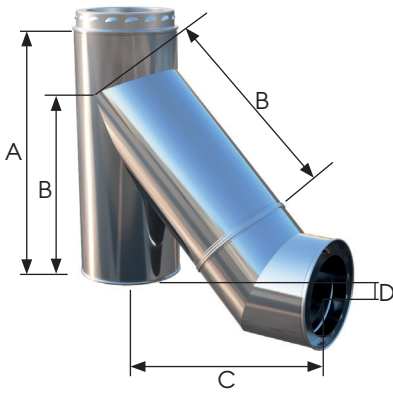

135° Tee & Elbow supplied separately.

Ø	Dimension (mm)						Code
	135° Tee		With 40° Elbow		With 45° Elbow		
	A	B	C	D	C	D	
100mm	495	325	385	23	385	31	4576504N
130mm	495	340	407	22	407	30	4576505N
150mm	495	375	439	29	439	38	4576506N
180mm	745	420	481	37	481	47	4576507N
200mm	745	450	509	43	509	53	4576508N
250mm	745	520	577	55	577	65	4576510N
304mm	745	585	625	73	625	84	4576512N
355mm	995	650	688	84	688	96	4576514N

## 135° Tee (N/D)

An alternative 135° equal tee for use on negative draught (NI) and dry non condensing systems (D). Mainly for use on multi-fuel stoves or applications that do not produce condensates or positive pressures within the system. Only available in Ø130 and Ø150 sizes.

Ø	Code
130mm	4570105N
150mm	4570106N

## Support Components

### Roof / Rafter Support

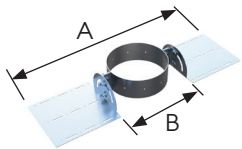

Designed to allow a chimney to be supported on roof joists, trussed rafters etc. Supplied with a diameter specific rotational clamp band. Maximum suspended chimney length is 9m when supported in a truss or 6m when supported below the truss. Suits up to 600mm rafter span.

Ø	A	B	Code
100mm	418	310	7072610
130mm	448	340	7072613
150mm	468	360	7072615
180mm	498	390	7072618
200mm	518	410	7072620
250mm	568	460	7072625
304mm	618	510	7072630
355mm	668	560	7072635

### Universal Roof/Rafter Support

As with the roof / rafter support above, but with a gimbal plate that is universal across all diameters. The gimbal plate is adjusted on site to match the outside diameter of the chimney. Suits up to 600mm rafter span.

Ø	A	B	Code
All	220	203	7002900

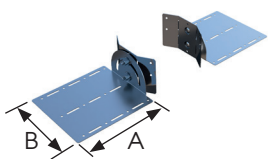

### Universal Split Band

Offers lateral support to the chimney system. The split band has adjustable brackets to allow the support of inclined runs. Design for use with M10 Drop Rod.

Ø	Code
100mm	3123150
130mm	3123180
150mm	3123200
180mm	3123230
200mm	3123250
250mm	3123300
304mm	3123350
355mm	3123400

### Support length (Strut/Guy Attachment)

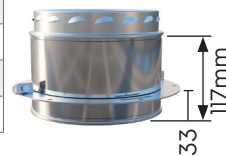

The support length is used with all wall support brackets and console plates, while on its own can be used as a guy wire bracket or for securing rigid stays to the chimney system.

Ø	Code
100mm	4578804N
130mm	4578805N
150mm	4578806N
180mm	4578807N
200mm	4578808N
250mm	4578810N
304mm	4578812N
355mm	4578814N

## Adjustable Wall Bands

The adjustable wall bands are available in short, medium and long. Designed to offer a single component solution to cover a range of clearances from the structure to the surface of the flue pipe. Supplied fully assembled for ease of installation. Designed specifically for residential installation. Must be used at intervals not exceeding 4.0 metres beyond any load bearing support.

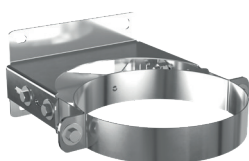

**Short**  
(Min 52mm Max 100mm)

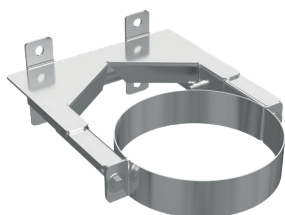

**Medium**  
(Min 75mm Max 155mm)

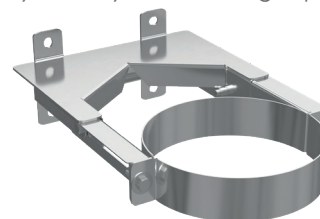

**Long**  
(Min 100mm Max 210mm)

∅	Code
130mm	3115185EXT
150mm	3115205EXT

∅	Code
130mm	3110013
150mm	3110006

∅	Code
130mm	3100013
150mm	3100006

## Standard Wall Bands

Wall bands provide lateral support for the chimney and must be used at intervals not exceeding 4.0 metres beyond any load bearing support. Offers 50mm clearance between the structure and the surface of the flue.

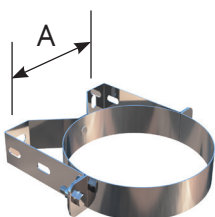

∅	Dim	Stainless Code
	A	
100mm	112	3115154
130mm	142	3115185
150mm	162	3115205
180mm	192	3115234
200mm	212	3115255
250mm	266	3115305
304mm	316	3115355
355mm	366	3115405

## Wall Band Extension Pieces (Short)

Used with the standard wall bands, these components allow the clearance between the wall and outer surface of the chimney to be increased. Where externally applied, the intervals between Wall Band fixing centres must be reduced from 4.0 metres to 3.5 metres. The maximum clearance is as detailed below.

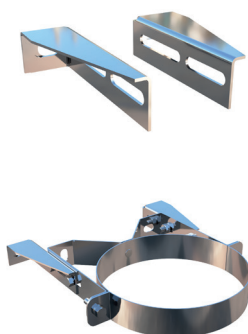

∅	Extension		Stainless Code
	Min	Max	
100mm	65	105	3119136
130mm	50	100	3119136
150mm	50	100	3119136
180mm	50	100	3119136
200mm	50	100	3119136
250mm	50	100	3119180
304mm	75	140	3119245
355mm	50	120	3119245

## Heavy Duty Medium & Long Extension Brackets

Designed for use with the standard Wall Band (3115XXX). This component is ideal where the wall band position needs to be extended away from the structure by greater than the standard 50mm clearance. Ideally suited where the chimney is positioned away from the structure to avoid the soffit and guttering without the need to offset. Available in bright annealed stainless steel or black and offered in sizes 300mm and 450mm long. Can be cut to length on site if required.

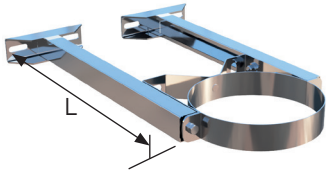

	L	Code
Wall Band Extension T-Bars	300	3115001
	450	3115002

## HD Wall Band

Can be used where additional bracing is required or used with Extension Brackets to increase the clearance from the building, e.g. for offsets. Supplied with nut inserts for easy installation.

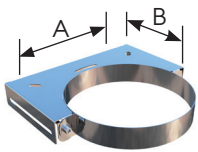

Ø	A	B	Code
100mm	220	175	3109510
130mm	250	140	3109513
150mm	270	150	3109515
180mm	300	165	3109518
200mm	320	175	3109520
250mm	370	200	3109525

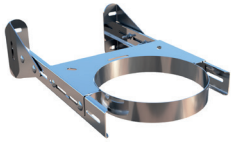

## HD Extension Brackets

Available in Short and Medium versions to offer greater flexibility. Extension Brackets can only be used with the HD and EasyFit Wall Bands. The Extension Brackets can be cut to length on site if required. The side strengthening braces must be used where the clearance exceeds 200mm.

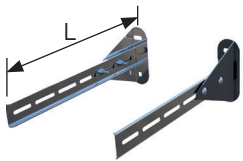

Size	L	Code
Short	324	31093ST
Medium	395	31093MD

## EasyFit Wall Band

Can be used to add additional lateral support when the chimney has already been installed. Where used on its own, it must be positioned at intervals not exceeding 3.0 metres.

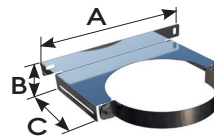

Ø	A	B	C	Code
127mm	294	76	136	3109613
152mm	314	76	147	3109615

## Universal Roof Bracing Bracket

Used to offer additional lateral bracing above the roof level. Idea when installing offsets around fascia boards or where higher termination heights are required. The telescopic legs are adjustable between 1650mm - 2900mm, while the clamp band features nut inserts for ease of installation.



Ø	A	Code
100mm	150	7073310
130mm	180	7073313
150mm	200	7073315
180mm	227	7073317
200mm	250	7073320
250mm	300	7073325

## Maximum/minimum distances for wall bands and extension brackets

Ø	Max Short	Max Medium	Min With Side Brace	Min Without Side Brace
100mm	312	383	277	130
130mm	312	383	292	145
150mm	312	383	302	155
180mm	312	383	317	170
200mm	312	383	327	180
250mm	312	383	352	205

Note: The HD Extension Brackets are mainly designed for internal applications. For external applications the Heavy Duty Medium and Long Extension Brackets with the Standard Wall Band are preferred.

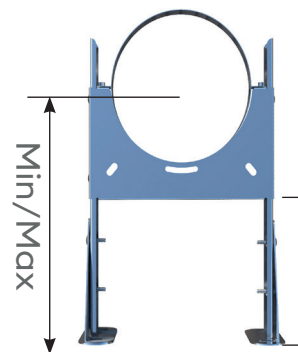

Side Braces must be used where the required extension is greater than 200mm from the attaching structure to the rear of the Wall Band

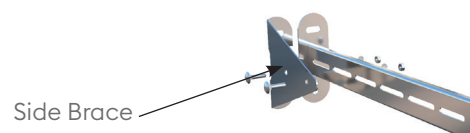

## Wall Support Bracket

Used to take the vertical load of the chimney when supported from a wall. The support bracket is fully adjustable allowing varying clearances from the wall (50mm as standard). Requires M10 wall fixings. Supplied complete with 45788XX Support Length.

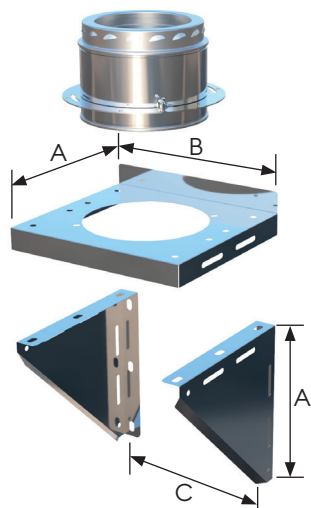

∅	A	B	C	Stainless Code	Adjustment
100mm	252	281	235	4572304	50 - 150
130mm	282	311	265	4572305	50 - 150
150mm	302	331	285	4572306	50 - 150
180mm	331	360	314	4572307	50 - 200
200mm	355	384	338	4572308	50 - 200
250mm	403	432	384	4572310	50 - 220
304mm	453	482	434	4572312	50 - 267
355mm	504	533	485	4572314	50 - 293

For loading details and maximum distance between supports, please refer to the separate Nova Installation Instructions.

## EasyFit Wall Support Bracket

The EasyFit wall support bracket is a frictional support component designed to take up to 15 metres of product, making it ideal for use on bungalows and some two story houses. Designed for ease of installation and offers between 50mm and 200mm of adjustment from the structure to the surface of the flue pipe. Available in residential sizes Ø127 and Ø150.

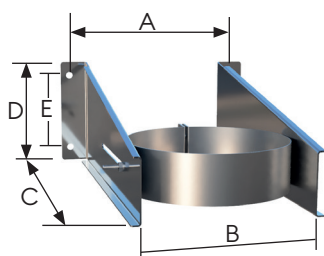

∅	A	B	C	D	E	Adjustment	Code
130mm	234	180	400	150	110	50mm - 200mm	3130113
150mm	260	206	400	150	110	50mm - 200mm	3130115

## Console Plate

The console plate is used as part of the cantilever wall support bracket and is purchased separately. Available in residential sizes Ø130 and Ø150.

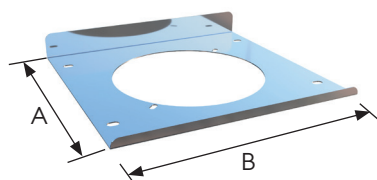

∅	A	B	Code
130mm	282	305	3118005
150mm	302	325	3118006

## Cantilever Wall Bracket

The cantilever wall support is supplied in a set, each one 570mm long. They are designed for use with the 31180XX console plate and the 45788XX support length. This assembly provides a complete heavy duty wall support bracket, allowing the chimney to be supported up to 300mm clear from the wall, while supporting up to 40 metres in sizes Ø130 and Ø150. An ideal solution for residential installations where the chimney is positioned away from the building, so as to allow a straight vertical rise past the soffit and gutter, without the need to offset the chimney.

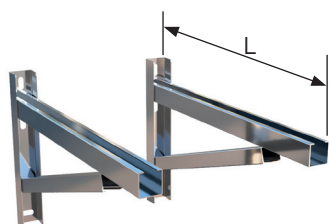

∅	L	Code
130mm / 150mm	570	3122570

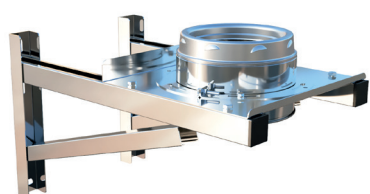

Where XX is the diameter

$$\begin{array}{c}
 \text{Cantilever Wall Bracket} \\
 3122570
 \end{array}
 =
 \begin{array}{c}
 \text{Cantilever Wall Bracket} \\
 3122570
 \end{array}
 +
 \begin{array}{c}
 \text{Console Plate} \\
 31301XX
 \end{array}
 +
 \begin{array}{c}
 \text{Support Length} \\
 45788XXN
 \end{array}$$

## Universal Support Plate

A support plate designed for use with bespoke bracketry such as Uni-Strut/Niessing or site fabricated. Supplied complete with a Support Length. Fixing hole size 11mm to suit M10 fixings.

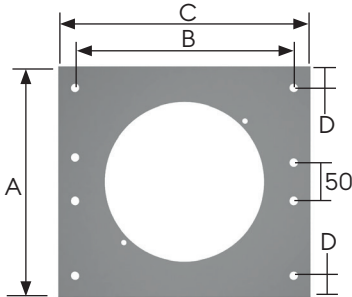
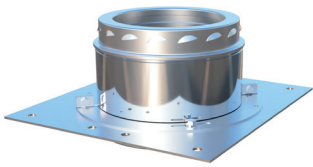

∅	A	B	C	D	Max Load	Stainless Code
100mm	281	196	252	22	13m	4571704N
130mm	311	226	282	22	13m	4571705N
150mm	331	246	302	22	13m	4571706N
180mm	360	275	331	22	13m	4571707N
200mm	384	299	355	22	13m	4571708N
250mm	432	345	403	22	13m	4571710N
304mm	482	395	453	22	13m	4571712N
355mm	533	446	504	22	13m	4571714N

## Single Wall to NOVA Anchor Plate

Designed to be used when connecting NOVA to a lintel or pre-cast chamber. Also suitable for connection to a chimney liner when re-instating a masonry chimney that has been dismantled down to the attic.

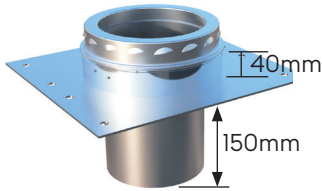

∅	A	B	C	Max Load	Code
100mm	281	196	252	13m	4577504N
130mm	311	226	282	13m	4577505N
150mm	331	246	302	13m	4577506N
180mm	360	275	331	13m	4577507N
200mm	384	299	355	13m	4577508N
250mm	432	345	403	13m	4577510N
304mm	482	395	453	13m	4577512N
355mm	533	446	504	13m	4577514N

## SELFLEX To NOVA Anchor Plate - Screwed Connection

Used to connecting SELFLEX to NOVA when capping and re-instating and existing masonry chimney within the attic space. Supplied with a SELFLEX screwed adaptor for ease of installation. Can suspend up to 16m of flexible liner in Ø127 and Ø150, while supporting a vertical load of up to 13m.

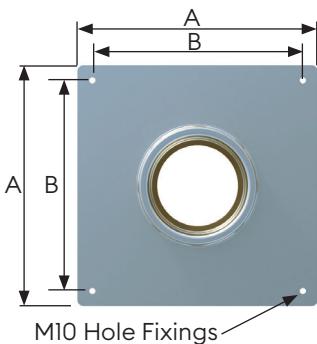
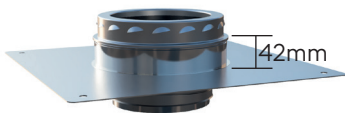

∅	A	B	Max Load	Code
130mm	400	350	13m	0593712
150mm	400	350	13m	0593715

# Floor & Ceiling Penetrations

## Combustible floors

# NOVA

For solid fuel applications where there is a risk of a chimney fire or where the flue gas temperatures can exceed 250°C but not greater than 450°C, the following penetration components must be used when passing through a floor or ceiling. Each ventilated component offers a 50mm distance to combustible materials. In all cases the 50mm clearance to combustible materials **MUST** be maintained throughout the installation.

### Ventilated Ceiling Supports

These are used to both support and firestop the chimney system when it passes through the first combustible floor, directly above the appliance. The ventilation slots allow passive ventilation of the enclosure to prevent heat buildup.

### Standard Ventilated Ceiling Support Kit (T450)

Incorporates an Upper Ventilated Support Plate and Lower Firestop Assembly. The lower assembly also incorporates an intumescent matrix design which expands rapidly in the presence of fire and seals the ventilation slots to prevent smoke and potential spread of fire from the room below. Manufactured in bright annealed stainless steel, but also available painted black (add a ZB to the code), or white (add a ZW to the code).

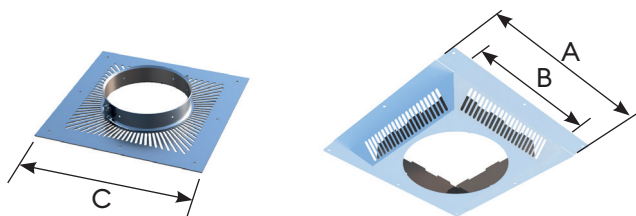

∅	A	B	C	Code
100mm	311	251	349	7072710
130mm	361	281	379	7072713
150mm	381	301	399	7072715
180mm	411	331	429	7072718
200mm	431	351	453	7072720
250mm	481	401	501	7072725
305mm	531	451	551	7072730

### D5 White Ventilated Ceiling Support Kit (T450)

The D5 offers an aesthetically pleasing flat appearance to the Standard Ventilated Ceiling Support, while still incorporating an intumescent matrix for maximum fire safety. This component is finished in a high quality white gloss finish.



∅	A	B	Code
100mm	322	249	7072810ZW
130mm	352	279	7072813ZW
150mm	372	299	7072815ZW
180mm	402	329	7072818ZW
200mm	422	349	7072820ZW

### Ventilated Firestop (T450)

Used where the chimney passes through the upper combustible floors, and where sections below the floor are enclosed within a non combustible shaft. This item is not load-bearing.

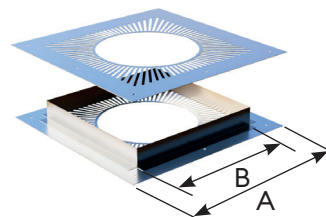

∅	A	B	Code
100mm	349	251	5508310
130mm	379	281	5508313
150mm	399	301	5508315
180mm	429	331	5508318
200mm	453	351	5508320
250mm	501	402	5508325
305mm	551	452	5508330

## Non-Combustible floors

The following components can be used on gas or oil fired appliances, where the flue gas temperature does not exceed 250°C, and/or where the chimney passes through a non-combustible floor / enclosure. **In all cases the 50mm clearance to combustible materials MUST be maintained throughout the installation.**

### Ceiling Support Kit

Provides a 50mm air gap clearance to a penetrated floor or ceiling and is only used when penetrating a non-combustible floor, and/or services a gas or oil fired appliance where the flue gas temperature does not exceed 250°C.

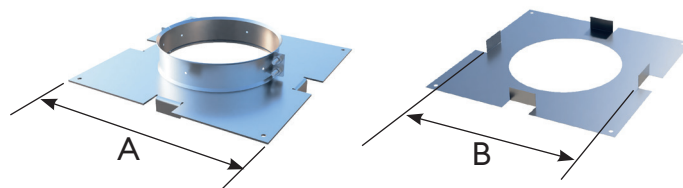

∅	A	B	Code
100mm	300	250	45027
130mm	330	280	45027
150mm	355	305	45027
180mm	381	331	45027
200mm	406	356	45027
250mm	457	407	45027
305mm	507	457	45027
355mm	558	508	45027

## Firestop Spacer

Used to provide location, fire and dust stopping where NOVA is used through non-combustible floors, and / or serves a gas or oil fired appliance where the flue gas temperatures does not exceed 250°C. This item does not load bear.

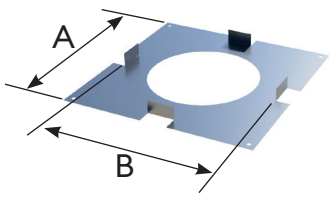

∅	A	B	Code
100mm	300	250	45027
130mm	330	280	45027
150mm	355	305	45027
180mm	381	331	45027
200mm	406	356	45027
250mm	457	407	45027
305mm	507	457	45027
355mm	558	508	45027

## Intumescent Sealant

Required for the correct installation of the Ventilated Ceiling Support Kits & Firestops. Refer to installation instructions for more information.



Size	Code
290ml	0199900

## Terminals



### Top Stub

The Top Stub terminal offers the least resistance to flue gas and is ideal for solid fuel and oil-fired appliances, providing there is drainage at the base of the chimney.

### Top Stub With Mesh

Ideally suited for condensing/high efficiency gas appliances. Not suitable for solid fuel application or where there is no provision for drainage below termination.

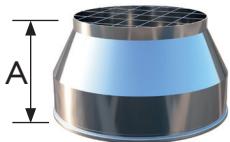

∅	Dimension (mm)		Code	Dimension (mm)	
	A			A	Code
100mm	100		4570804	100	4570704
130mm	100		4570805	100	4570705
150mm	100		4570806	100	4570706
180mm	100		4570807	100	4570707
200mm	100		4570808	100	4570708
250mm	100		4570810	100	4570710
304mm	100		4570812	100	4570712
355mm	100		4570814	100	4570714

### Rain Cap

The Rain Cap offers a degree of protection from rain and is suitable for multi-fuel and oil fired appliances.

### Round Top

The Round Top offers a greater degree of protection against driving rain and wind and is recommended for exposed locations. Suitable for multi-fuel and oil fired appliances.

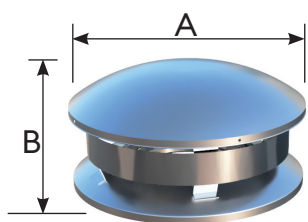
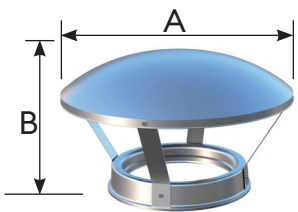

∅	Dim (mm)		Code	Dim (mm)		Code
	A	B		A	B	
100mm	255	192	4577304	255	155	4573104
130mm	255	197	4577305	300	159	4573105
150mm	300	204	4577306	300	157	4573106
180mm	358	265	4577307	358	189	4573107
200mm	402	265	4577308	402	194	4573108
250mm	500	300	4577310	500	253	4573110
304mm	716	345	4577312	716	288	4573112
355mm	716	385	4577314	716	356	4573114

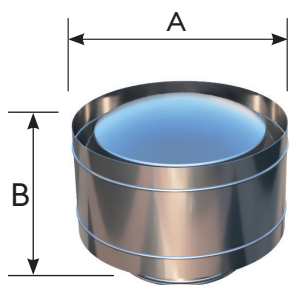

### Storm Cowl

The Storm Cowl is designed to offer maximum protection against driving rain and strong winds. Please note that this is not an anti-downdraught terminal.

### Storm Cowl with Mesh

As Storm Cowl but for gas fired applications, not suitable for use on solid fuel.

ø	A	B	Code	A	B	Code
100mm	270	165	4578704	270	165	4578904
130mm	294	165	4578705	294	165	4578905
150mm	319	165	4578706	319	165	4578906
180mm	344	165	4578707	344	165	4578907
200mm	369	165	4578708	369	165	4578908
250mm	419	210	4578710	419	210	4578910

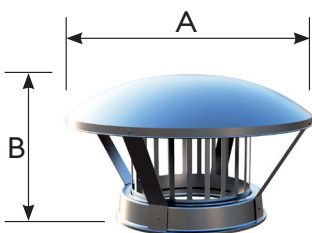

### Rain Cap with Mesh

A standard rain cap featuring a slotted anti-bird guard mesh for use on multi-fuel stoves

### NOVA Mini EUROCOWL

The NOVA specific version of the most popular anti-downdraught cowl on the market, complete with a factory-fitted NOVA female coupler and locking band for effortless and secure installation.

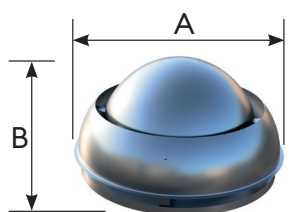

ø	A	B	Code	A	B	Code
130mm	255	197	4577305	294	175	4574505N
150mm	300	204	4577306	319	188	4574506N

## Flashings & Weathering

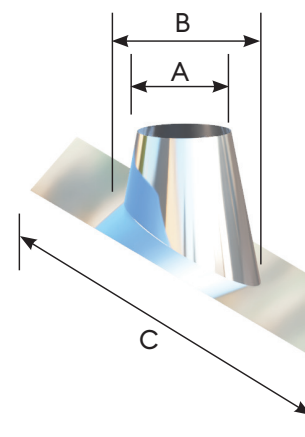
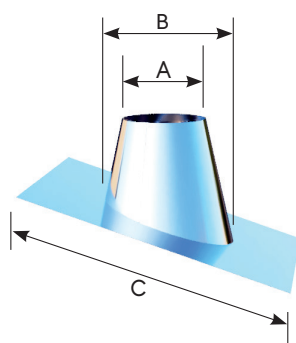
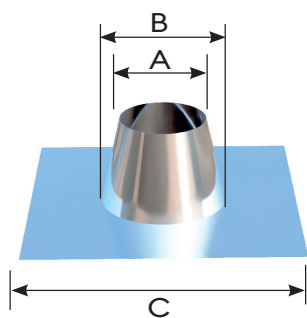

### Aluminium Flashings

The SFL aluminum flashing range offers a competitive alternative to the traditional lead flashing, while still maintaining a traditional design and malleable material. All aluminum flashings require a Storm Collar

#### Flat Flashing

For flat or nearly flat roofs.

#### 5° - 30° Adjustable Flashing

For low pitched roofs.

#### 32° - 45° Adjustable Flashing

For high pitched roofs.

ø	Dimension (mm)											
	A	B	C	Code	A	B	C	Code	A	B	C	Code
100mm	160	250	495	70000006	160	250	495	70053006	160	332	660	70324506
130mm	190	280	495	70000007	190	280	495	70053007	190	375	660	70324507
150mm	210	300	495	70000009	210	300	660	70053009	210	403	660	70324509
180mm	235	325	660	70000010	235	325	660	70053010	235	440	820	70324510
200mm	260	350	660	70000011	260	350	660	70053011	260	475	820	70324511
250mm	310	400	660	70000012	310	400	660	70053012	310	546	820	70324512
304mm	360	450	660	70000013	360	450	820	70053013	360	617	820	70324513
355mm	410	500	820	70000014	410	500	965	70053014	410	689	1219	70324514

## Aluminium Storm Collar

Used to weather/seal the top of the flashing, supplied with a tube of silicon sealant.

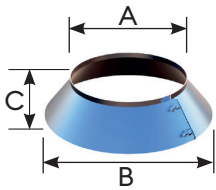

∅	A	B	C	Code
100mm	152	255	70	70123406
130mm	177	280	70	70123407
150mm	202	301	70	70123409
180mm	227	330	70	70123410
200mm	252	351	70	70123411
250mm	302	401	70	70123412
304mm	352	451	70	70123413
355mm	402	501	70	70123414

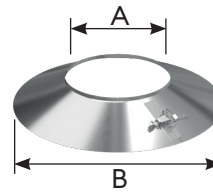

## NOVA Stainless Storm Collar

The NOVA polished stainless steel storm collar is larger and offers a greater degree of protection from weathering. It also adds a superb looking finish to your installation.

∅	A	B	Code
100mm	151	350	4504104
130mm	181	380	4504105
150mm	201	400	4504106
180mm	231	400	4504107
200mm	251	450	4504108

## EPDM Synthetic Rubber Flashing

The selection of the correct flashing depends on the outside chimney diameter and intended roof pitch. The table identifies which flashing should be used. Each consists of a malleable aluminium base to which an EPDM rubber cone is sealed. The cone is easily trimmed on site to suit the external diameter of the chimney. Separate installation instructions are provided with every flashing.

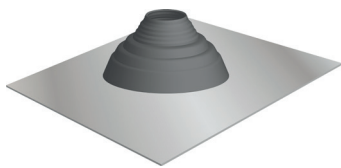

The EPDM flashing system will effectively seal and remain pliant over a wide range of external chimney surface temperature extremes from -30° to 115°C. The EPDM cones have also been proven to withstand intermittent surface temperatures of up to 150°C.

EPDM flashings should not be used on single wall chimney systems serving solid fuel appliances or any application where the potential surface temperature of the chimney will exceed the maximum design temperatures details above.

∅	Ext Dia (mm)	Roof Pitch	Flashing No.	Cone Index Cut Line	Base Size (A)	Code
100mm	150	0-35°	1	E	500x500mm	4901015
130mm	180	0-40°	2	E	600x600mm	4901020
150mm	200	0-30°	2	F	600x600mm	4901020
150mm	200	0-45°	3	C	764x764mm	4901030
180mm	230	0-40°	3	D	764x764mm	4901030
200mm	250	0-35°	3	F	764x764mm	4901030
250mm	300	0-30°	3	I	764x764mm	4901030
250mm	300	0-45°	4	A	956x956mm	4901045
304mm	350	0-40°	4	C	956x956mm	4901045
355mm	400	0-35°	4	F	956x956mm	4901045

## Adjustable 45° Wall Sleeves

Used where a 135° tee is required to pass the chimney through an external masonry wall. The wall sleeve is adjustable and can be used for wall thicknesses from 200mm - 380mm. Once the desired length is determined, the joint between the telescopic sections should be sealed with aluminium backed duct tape. Also available in stainless steel. The wall sleeve offers a clearance of 25mm between the outer case of the chimney and the internal sleeve.

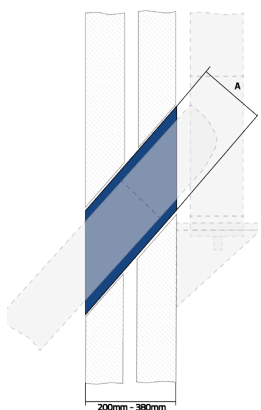

∅	A	Galvanised	Stainless
100mm	250	3107104	3107304
130mm	280	3107105	3107305
150mm	300	3107106	3107306
180mm	330	3107107	3107307
200mm	350	3107108	3107308
250mm	400	3107110	3107310
304mm	450	3107112	3107312
355mm	500	3107114	3107314

Not suitable for applications where the wall construction may contain combustible materials.

## Trim Collar

The trim collar is a polished stainless steel circular collar with a nominal 105mm wide circular flange. This item is used to offer an aesthetic closing ring where a chimney passes through an inside / outside wall.

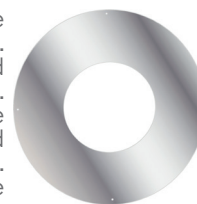

∅	Code
100mm	4583204
130mm	4583205
150mm	4583206
180mm	4583207
200mm	4583208
250mm	4583210
304mm	4583212
355mm	4583214

## Angled Wall Cover Ring

The wall cover ring is designed to offer an aesthetic trim around the chimney where it penetrates a wall at an angle. This component is available in five angle variations, 0°-10°, 10°-20°, 20°-30°, 30°-40° and 40°-50°.

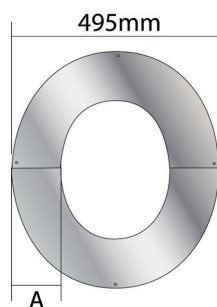

Ø	A	Wall Penetration Angle				
		0°-10°	10°-20°	20°-30°	30°-40°	40°-50°
		Code	Code	Code	Code	Code
130mm	156	7071213	7071313	7070013	7070313	7070213
150mm	146	7071215	7071315	7070015	7070315	7070215
180mm	131	7071218	7071318	7070018	7070318	7070218
200mm	121	7071220	7071320	7070020	7070320	7070220

## Accessories

### Locking Band

The locking band must be used on all joints and are included with each component having a female coupler.



Ø	Code
100mm	4578604
130mm	4578605
150mm	4578606
180mm	4578607
200mm	4578608
250mm	4578610
304mm	4578612
355mm	4578614

### Locking Band (Screw Toggle)

The screw-toggle locking band is provided as standard with the unbarbed female coupler on elbows and 135° tee branches.



Ø	Code
100mm	4578604MT
130mm	4578605MT
150mm	4578606MT
180mm	4578607MT
200mm	4578608MT
250mm	4578610MT
304mm	4578612MT
355mm	4578614MT

### Seal Lubricant

This must be applied around the circumference of the fitted seal to provide a lubricated interface between the seal and the liner when the product is used for positive pressure and wet applications.



Code	
250ml	3107500

Only SFL lubricant should be used as it has been specially formulated for use with both silicone and EPDM seal materials. Failure to use SFL lubricant when installing seals in NOVA product will invalidate the product warranty and potentially cause failure of the seal.

### Joint Sealing Ring (W/P1/H1)

This optional component is available for all diameters and is located in the joint groove as detailed in the Installation Instructions. This component when fitted offers condensate resistance and allows the system to operate under positive pressure conditions as detailed in Table A.



Important: SFL seal lubricating compound MUST be applied around the surface of the seal and interfacing surface prior to making the joint. It is also recommended that the seal is carefully bonded to the fixing groove prior to installation with a suitable silicon adhesive/sealant.

Ø	Code
100mm	4006310
130mm	4006313
150mm	4006315
180mm	4006318
200mm	4006320
250mm	4006325
304mm	4006430
355mm	4006435

### Joint Sealing Ring (W/P1) for 305mm and 355mm Adjustable Lengths ONLY

These seals are only to be used for the internal slip section of the 305mm and 355mm Adjustable Lengths. All other sizes utilise the standard Joint Sealing Ring as detailed above, Part No. 40063XX in the slip section.



Ø	Code
304mm	4006530
355mm	4006535

It is important that seals are regularly inspected as part of the routine maintenance schedule. Like all types of seal, they can deteriorate over time and need replacing. To ensure many years of service, it is critical that adequate drainage is provided within the system and all near horizontal runs rise at a minimum of 3° - 5°. All seals are CE marked to 14241-1 T200 W 2 K2 I for internal applications within the flow of condensate and are corrosion tested to Class 2 for use with natural gas and kerosene. As seals are classified as sacrificial they are covered by a 12 month manufacturing defects warranty.

The following pages offer technical information in respect to weights and dimensions. For full product installation instructions and application information, please see page XX for download instruction.

## Elbow offset dimensions

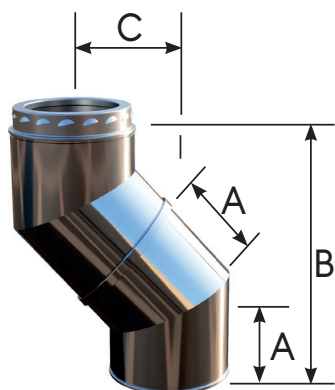

Fig. 1

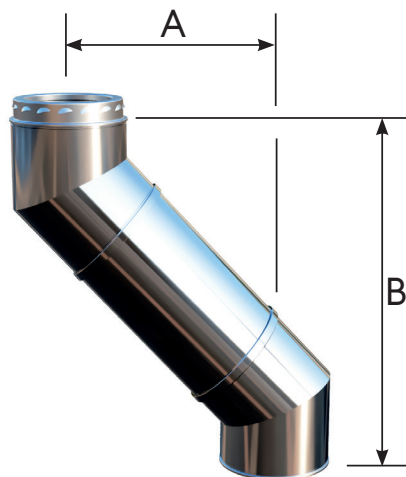

Fig. 2

This data relates to just two elbows used to form an offset as shown in Fig. 1. It also indicates the installed length of the elbow segments. Data is also provided where standard lengths are also incorporated within the offset, see Fig. 2.

Elbows are not load-bearing. Vertical runs after changes of direction should be re-supported appropriately.

### 15°

Ø (mm)	A (mm)	B (mm)	C (mm)
100mm	91	358	47
130mm	98	385	51
150mm	102	401	53
180mm	108	425	56
200mm	112	440	58
250mm	123	484	64
304mm	124	488	64
355mm	134	527	69

### 30°

Ø (mm)	A (mm)	B (mm)	C (mm)
100mm	91	340	91
130mm	98	366	98
150mm	102	381	102
180mm	108	403	108
200mm	112	418	112
250mm	123	459	123
304mm	124	463	124
355mm	134	500	134

### 40°

Ø (mm)	A (mm)	B (mm)	C (mm)
100mm	91	321	117
130mm	98	346	126
150mm	102	360	131
180mm	108	381	139
200mm	112	396	144
250mm	123	434	158
304mm	124	438	159
355mm	134	473	184

### 45°

Ø (mm)	A (mm)	B (mm)	C (mm)
100mm	91	311	129
130mm	98	335	139
150mm	102	348	144
180mm	108	369	153
200mm	112	382	158
250mm	123	420	174
304mm	124	423	175
355mm	134	457	190

Ø (mm)	120mm length							
	15°		30°		40°		45°	
	B (mm)	C (mm)	B (mm)	C (mm)	B (mm)	C (mm)	B (mm)	C (mm)
100mm	474	78	444	151	413	194	396	214
130mm	501	82	470	158	438	203	420	224
150mm	517	84	485	162	452	208	433	229
180mm	541	87	507	168	473	216	454	238
200mm	556	89	522	172	488	221	467	243
250mm	600	95	563	183	526	235	505	259
304mm	603	95	566	184	530	237	508	260
355mm	643	100	604	194	565	249	542	274

Ø (mm)	250mm length							
	15°		30°		40°		45°	
	B (mm)	C (mm)	B (mm)	C (mm)	B (mm)	C (mm)	B (mm)	C (mm)
100mm	599	112	556	216	513	278	487	305
130mm	627	115	582	223	538	287	511	315
150mm	643	118	597	227	551	292	525	321
180mm	666	121	620	233	573	299	546	330
200mm	682	123	634	237	587	305	559	335
250mm	725	129	676	248	626	319	597	351
304mm	729	129	679	249	629	320	600	352
355mm	768	134	717	259	665	333	634	366

Ø (mm)	500mm length							
	15°		30°		40°		45°	
	B (mm)	C (mm)	B (mm)	C (mm)	B (mm)	C (mm)	B (mm)	C (mm)
100mm	841	177	773	341	704	438	664	482
130mm	868	180	799	348	729	447	688	492
150mm	884	182	814	352	743	453	702	498
180mm	908	185	836	358	764	460	722	506
200mm	923	187	851	362	779	465	736	512
250mm	967	193	892	373	817	480	774	528
304mm	970	194	896	374	821	481	777	529
355mm	1010	199	933	384	856	494	811	543

Ø (mm)	1000mm length							
	15°		30°		40°		45°	
	B (mm)	C (mm)	B (mm)	C (mm)	B (mm)	C (mm)	B (mm)	C (mm)
100mm	1324	306	1206	591	1087	760	1018	836
130mm	1351	310	1232	598	1112	769	1042	846
150mm	1362	312	1247	602	1128	774	1055	851
180mm	1391	315	1269	608	1148	782	1076	860
200mm	1406	317	1284	612	1162	787	1089	865
250mm	1450	322	1325	623	1200	801	1127	881
304mm	1453	323	1329	624	1204	802	1130	882
355mm	1493	328	1366	634	1239	815	1165	897

## Wall Support Bracket – Max. Loading

### Support configuration and distance between brackets

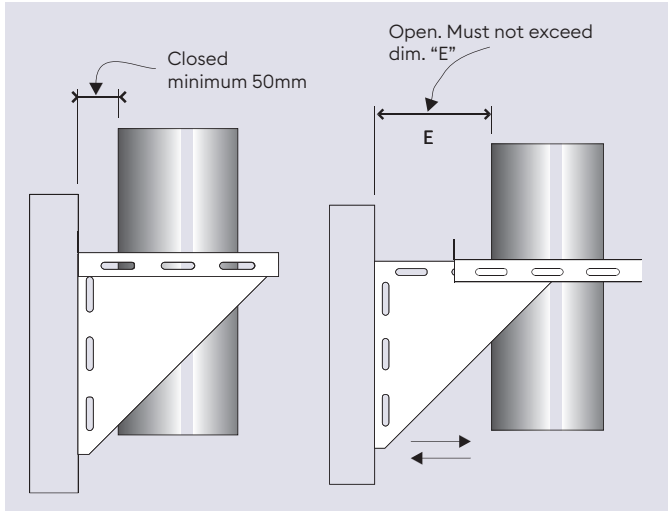

Ø	A (m)	B (m)	E (mm)
100mm	30	25	150
130mm	30	25	150
150mm	30	25	150
180mm	20	15	200
200mm	20	15	200
250mm	20	15	220
304mm	20	15	267
355mm	18	12	293

This table details the maximum distance in metres between wall supports, based on the support configuration below.

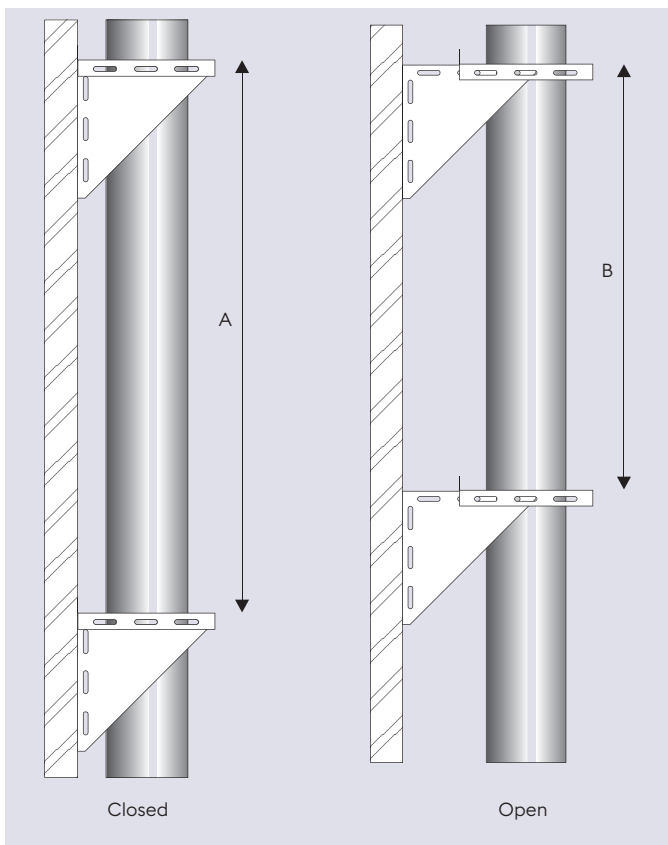

**IMPORTANT:** Wall support loadings are dependent on appropriate wall fixings and the structural integrity of the wall itself.

## Product weights

Maximum weight of NOVA® per metre run installed, excluding support components.

Ø (mm)	100	130	150	180	200	250	304	355
kg/m	6.6	8.1	9.2	10.8	11.8	14.5	17.1	19.7

## Maximum structural considerations for components

The table below shows the maximum number of metres that can be applied to various components. It is essential that these are not exceeded. Where possible components such as inlet tees and inspection lengths should not be vertically loaded, but suspended below a support component, such as the wall support assembly. Where this is unavoidable, refer to the maximum heights in the table below.

Components	Diameter (mm)							
	100	130	150	180	200	250	304	355
Inspection length	13m	13m	13m	13m	13m	13m	13m	12m
Ceiling support	6m	6m	6m	6m	6m	6m	6m	6m
Ventilated ceiling support	6m	6m	6m	6m	6m	6m	6m	6m
Anchor plate	13m	13m	13m	13m	13m	13m	13m	13m
Universal support plate	13m	13m	13m	13m	13m	13m	13m	13m
95° & 90° tee	13m	13m	13m	13m	13m	13m	13m	13m
135° tee	13m	13m	13m	13m	13m	13m	13m	13m

## Adjustable Slip-Length with Cover Jacket

Component extension limits above an existing length

Dia Ø	Combined adjustment range on standard lengths							
	Extension		250mm		500mm		1000mm	
	Min	Max	Min	Max	Min	Max	Min	Max
100mm	48	295	300	545	550	795	1050	1295
130mm	50	295	300	545	550	795	1050	1295
150mm	50	244	300	494	550	744	1050	1244
180mm	48	280	300	530	550	780	1050	1280
200mm	48	270	300	520	550	770	1050	1270
250mm	48	245	300	495	550	745	1050	1245

N.B. The Adjustable Slip Length requires a standard length to make a complete component. Adjustable lengths are not load-bearing. A support component should be used immediately above.

## IMPORTANT (Always Read The Product Installation Instructions)



For detailed information regarding design, installation and application data for this product, scan the QR code and download the full Nova Installation Instructions from our website at [www.sflchimneys.com](http://www.sflchimneys.com).



# RESIDENTIAL

Vitreous Enamel

## SVIT



Quick Installation



Brand Compatibility



No Sealant Required



Year Product Warranty

**SVIT®** is a vitreous enamel-coated steel connecting flue pipe designed to facilitate the connection between a multi-fuel appliance, an existing brick chimney or a prefabricated twin wall chimney system. It offers a smooth, aesthetically pleasing joint, without the need for additional locking bands or fire cement and is available in 100mm, 125mm, 150mm, 180mm & 200mm.

Twin Wall / Air Gap Insulation

## IL



125-150mm Diameter



T250 Rating



Multi-Fuel Appliances

**IL®** is a twin wall air gap insulated prefabricated domestic and light commercial gas vent system suitable for gas appliances, with draught-hoods or with a flue gas temperature not exceeding 250°C and zero or negative pressure in the flue. Lengths and fittings push and twist lock together to provide strong rigid flue systems and ensure maximum ease of site assembly.

Flexible Liner

## SELFLEX



V2 Corrosion Resistant



P1 / N Rating



Brand Compatibility



Year Product Warranty

**SELFLEX®** is a double skin multi-fuel flexible chimney liner suitable for multi-fuel, gas, and oil-fired applications up to a maximum flue gas temperature of 600°C. CE marked to EN 1856-2. The SELFLEX® family range is suitable for the relining of masonry flues and used with wood, multi-fuel stoves and open fires and is available in three different specifications including 0.1mm 904L, 0.12mm 316L and 0.1mm 316L.

Insulated Flexible Liner

## TUBEX PLUS

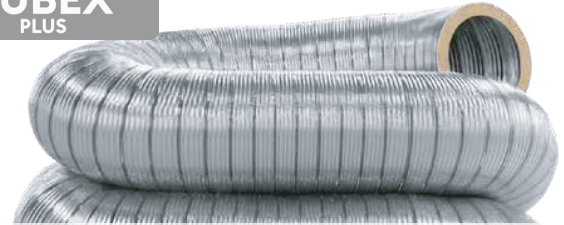

V2 Corrosion Resistant



Brand Compatibility



125-150mm Diameter



Product Warranty

**TUBEX PLUS®** is a unique insulated flexible liner for multi-fuel applications that allows maximum flexibility and ease of installation, the insulated core offers excellent thermal resistance to maximise natural draft to ensure optimum efficiency of the appliance with its 13mm high density insulation layer. Ideal for use on modern high-efficiency wood burning and multi-fuel appliance and application.

Single Wall / Connecting Flue

## SIGMA



Quick Installation



Brand Compatibility



T600 Rating



Year Product Warranty

**SIGMA®** is a stainless-steel single wall connecting flue pipe for use with multi-fuel appliances, brick chimneys, twin wall systems and flexible liners. Available in four diameters 127mm, 152mm, 178mm and 203mm manufactured for wood and multi-fuel burning appliances it has a gas-tight joint that negates the need for fire cement or rope. Manufactured from 1mm 316L for optimum long term performance.

Twin Wall / Twist Lock

## S-FLUE



T450 Rating



Brand Compatibility



127-203mm Diameter



Year Product Warranty

**S-FLUE®** is a stainless steel insulated twin wall chimney system. Ideally suited for use on multi-fuel stoves and heating equipment. Offered in natural stainless steel or a satin black finish. Supplied complete with SFL's EasyFit low profile locking band system for the ultimate ease of installation.

# COMMERCIAL

Twin Wall / Push Fit

## KEPLER HPT



5000Pa  
T600 Dry



Easy To  
Install



No Bellows



Ideal For  
Gen-Sets

Single Wall / Push Fit

## SUPRA PLUS



Multi-Fuel  
Appliances



Up To  
5000Pa



T600 Dry  
T200 Wet



Quick  
Installation



Year Product  
Warranty

KEPLER HPT is a push-fit twin wall insulated high pressure generator exhaust system suitable for high temperature / high pressure dry non-condensing applications. Supplied as standard with a 50mm high density insulated annulus. Due to its unique design, the KEPLER HPT generator system does not require expansion components, such as expansion bellows. Available in a range of sizes covering Ø80 - Ø600.

**SUPRA PLUS®** is a British built single wall chimney system designed specifically for today's modern high efficiency appliances that operate under positive pressure and condensing conditions.

Manufactured in 9 diameters ranging from 80mm to 350mm and consists of a range of lengths and fittings which simply push-fit together, and which are secured with a locking band. Seals are factory fitted and bonded for ease of installation. Available with a wide range of support components that cater for both lateral and vertical structural loading of the product. Extended range available from 400mm to 600mm.

Twin Wall / Twist Lock

## NOVA



EI90  
Fire Rated



Up To  
5000Pa



T600 Dry  
T200 Wet



Multi-Fuel  
Appliances



Year Product  
Warranty

**NOVA®** is a pre-fabricated, factory-made twin-wall, insulated stainless steel chimney system. Suitable for condensing and positive pressure applications and is specifically designed to meet the demands of the latest high-efficiency heating appliances as well as traditional gas and oil-fired combustion equipment. With its unique multi-barb twist-lock jointing system.

Manufactured in 8 internal diameters, ranging from 100mm to 355mm and consists of a wide range of components, together with a strong 16-barb twist lock jointing system, NOVA offers the ultimate in ease of installation and functionality. With its strong joint design, NOVA can achieve a maximum unsupported height of 3.0 metres above the last support (2.0 m for DN100), without the need for structural locking bands.

NOVA is fire resistance tested to BS EN 1366-13 and holds the following classification:

EI 90 (o → i) h<sub>o</sub> v<sub>e</sub>

NOVA has also been fire resistance tested for a period of 4 hours under the integrity criteria of BS476 Part 20.

Twin Wall / Flanged

## EUROPA PLUS



EI180  
Fire Rated



14,945Pa @ 760°C  
T600 Dry & Wet



CE, UKCA,  
UL ULc



Ø100 - Ø1200mm  
Diameters



Year Product  
Warranty

**EUROPA PLUS®** is a high pressure and high temperature chimney / exhaust system suitable for continuous operating temperatures of up to 600°C continuous and 750°C intermittent. Suitable for positive pressure systems up to 5000Pa (H1) and UL tested up to 14,945Pa.

It is offered as a double walled prefabricated 316L stainless steel chimney system, available in a range of insulation thickness to meet the most demanding applications. As standard, EUROPA PLUS incorporates a 25mm high performance insulated cavity, with the option to increase the cavity thickness to 50mm and 100mm for applications that demand critically controlled surface temperatures.

**EUROPA PLUS®** is fire resistance tested to the requirements of BS EN1366-13 up to 600mm:

EI 180 (o → i) h<sub>o</sub> v<sub>e</sub>

Above 600mm EUROPA PLUS is fire resistance tested to the integrity and stability requirement of BS 476 Part 24 for a period of 4 hours.



## At the forefront of flue and chimney manufacturing and technology.

Since 1969 SFL have been leading the way in flue and chimney innovation and technology. Our portfolio of trusted chimney and flues brands are known throughout the world for their engineering excellence. We offer industry-leading technical support services throughout the whole process of design, manufacture, and supply for commercial, domestic, and industrial applications, with uncompromised customer service.

We are proud of our British built heritage at SFL. Our manufacturing centre is based in Barnstaple, Devon, UK, alongside our extensive R&D centre, ensuring continuous product development and testing to the latest Standards.

SFL is part of the Sphering group, Sphering is an EU market maker with renowned expertise in design, manufacturing and distribution of advanced air and flue care systems.

### WeLab®

As a committed company determined to play an active role towards the environment and society, the Group has its own R&D centre: WeLab®. This facility has allowed the group to comply with the newest European standards (including the NZEB: nearly zero energy building) in terms of security and performance of appliances, but also to adopt a responsible innovation approach. With our WeLab®, we have developed test rigs based on minimum requirements in order to guarantee our clients the highest levels of security and performance.

SFL branded products are synonymous with the highest quality – it is this reputation that enables specifiers, contractors, and householders to use our products with total confidence.

NOVA®

SUPRA PLUS®

EUROPA PLUS®

S-FLUE®

NEXUS®

SVIT®

SELFLEX®

TUBEX PLUS®

IL®

SIGMA®

**Over 50 years** of industry leading experience in the flue and chimney market.

**applications for more than 50**

**Commercial Solutions and Project Assistance**

For large-scale installations in commercial build range of flue systems with ease of install at the From complex header configurations to large-d accommodate almost every requirement for any

[sflchimneys.com](http://sflchimneys.com)

