

SFL[®]

FLUE & CHIMNEY

Twin wall air gap insulated prefabricated domestic and light commercial gas vent chimney system designed and built in Britain.

The IL range from SFL.

IL

Twin Wall Air Gap Insulated Flue

Residential & Light Commercial Gas Vent System



BRITISH BUILT
FLUE & CHIMNEY SYSTEMS FROM SFL



PRODUCT INFORMATION

INTRODUCTION

IL is a factory-made twin-wall gas vent system comprising of a range of straight pipe lengths and associated fittings and accessories. It is constructed with an aluminium liner protected by an outer casing of galvanised steel.

An air gap between the outer casing and the inner lining insulates the vent and thus ensures a strong draft at the start of firing to minimise condensation. The resulting low external temperature under operating conditions permits installation with only 50mm (2in) clearance to combustible materials.

Lengths and fittings lock together positively to provide a strong rigid flue system and to ensure maximum ease of site assembly. Available in two diameters from 125mm to 150mm (5in to 6in).

IL gas vent is suitable for residential and small commercial atmospheric gas appliances with inputs of up to 60kW. It is suitable for both internal and external applications; however, external applications must not exceed 3 metres as detailed in BS 5440-1. For such applications either our Nova or Sflue chimney products should be used.

Quality/Approvals

The IL product is manufactured and certified to BS EN 1856-1 (Certificate number 2797-CPR-496040) to the performance designations as detailed in Table A. IL is also certified under BS EN 1856-1 to UKCA, certificate number 0086-CPR-740592.

All components are manufactured under a Quality Assurance Scheme, certificate No. FM557622, administered by British Standards in accordance with BS EN 9001:2015.

DESCRIPTION

Composition and manufacture

All lengths and fittings are available with the outer casing fabricated from galvanised steel. The flue liner is aluminium. Vertical seams are rolled and securely locked. The inner and outer casing are joined at one end only and a 6mm (1/4in) air gap is incorporated: the inner liner is thus free to expand as the temperature changes in the vent.

Size range and limits of application

The system comprises two diameters to provide for appliances rated up to 60kW input. Unless otherwise stated, all fittings and accessories are available in the two sizes.

The IL product is only suitable for atmospheric appliances and is NOT suitable for condensing or positive pressure systems or where the flue gas temperature may exceed 250°C. For such applications please refer to either our Supra Plus or Nova products.

Table A - IL Product Designations To BS EN 1856-1

Cert. No: 2797-CPD-496040 IL BS EN 1856-1 T250 N1 D Vm L11030 Q(50)	
Product	IL
Standard Number	BS EN 1856-1
Temperature Class	T250
Pressure Class	N1
Condense Resistance D=Dry W=Wet	D
Corrosion Class	Vm
Material Specification Liner: EN AW - 1200A Aluminium Liner Thickness: 0.3mm	L11030
Sootfire Resistance G=Yes O=No Distance to combustible: 50mm	Q(50)

GENERAL APPLICATION GUIDANCE

Installation instructions will be found on pages 6 & 7 and are provided with Terminals, Ridge Tile Adaptors, Draughthood Connectors and Flue Gas Boxes.

Joining

All lengths and fittings are designed to be installed with the male coupling uppermost. The female swaged coupling of the next component is simply pushed into place and twisted to provide a firm and secure connection by a simple locking device. See fig 2 on page 6.

Supports and clearance from combustibles

Wall bands are available in the full range of sizes to suit the vents and, for wall-fixed installations should be used at 3m (10ft) centres. The bands give a nominal 50mm (2in) clearance to the wall and provide lateral stability.

Note: Where the Gas Vent extends more than 1 metre above last support, (excluding the terminal), it MUST be braced.

A Support Plate is available which, together with the Flanged Collar, provides support for the vent at floor penetrations. The heavy Support Plate is fixed on top of the floor joists or slab and the Flanged Collar is clamped around the vent. The flange rests on the plate. A Firestop Plate is used on the underside of the ceiling penetration. Both components provide a 50mm (2in) minimum required air gap clearance from combustibles.

The maximum height of vent that can be supported is 18m (60ft).

Lengths of vent

Five lengths are available from 152mm to 1524mm (6in to 5ft) and these may be used in combination to make-up the required height. The installed length of each unit is 38mm (1 1/2in) less than the overall length.

In addition, two adjustable lengths are available to provide sufficient flexibility to obtain an exact required height of vent. These units telescope over any standard length to permit extension from 75mm to 356mm (3in to 14in) for the 457 (18in) unit and 75mm to 203mm (3in to 8in) for the 305mm (12in) unit.

Roof penetrations

Flat and Adjustable Flashings of sheet aluminium are available to provide suitable weather cover where the vent penetrates a roof.

The Flat Flashing is suitable for flat or nearly-flat roofs. The adjustable flashings are suitable for pitches from nearly-flat to 45°. The Adjustable Flashings are available to order with a malleable base for shaped tile flashing.

Aluminium Storm Collars are provided separately from Flashings and should be fitted to the vent immediately above the Flashing. The Collars are a tight fit to the vent and should be sealed with the silicone sealant provided.

EPDM synthetic rubber flashings are also ideal for the IL Gas Vent system. See separate literature.

Note: If a lead flashing is used, make sure that the seal is thoroughly made so that the risk of moisture influenced corrosion cannot occur where the lead touches the outer skin of IL Gas Vent.

Terminations

Terminating components include Ridge Tile Adaptor and a fabricated aluminium Gas Vent Terminal. Terminals have been designed for effective exclusion of rainwater while permitting rapid exit of gases.

PRINCIPAL DIMENSIONS

Size (internal diameter)	Maximum outside diameter
125mm (5in)	140mm (5 1/2in)
150mm (6in)	165mm (6 1/2in)

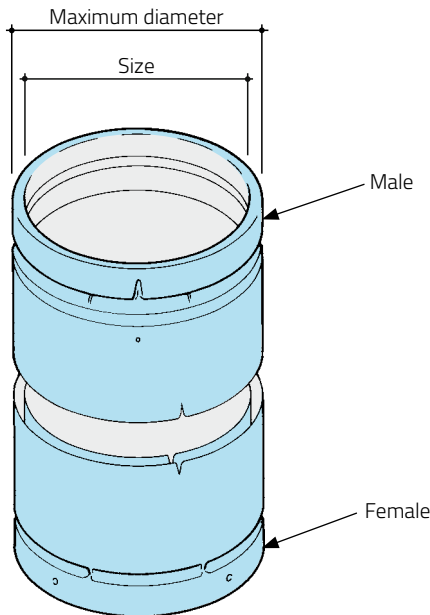

Note: IL IS only suitable for natural draught (negative pressure) venting systems operating under dry flue gas conditions. Under **NO** circumstances should the product be used on condensing appliances or where the venting system is designed to operate under positive pressure conditions. For condensing appliances and positive pressure systems, products such as Nova twin wall or Supra Plus single wall should be used.

SFL Flue Gas Boxes

For rooms without a chimney, a gas fire can be fitted by using a Gas Flue Box and a rigid twin wall chimney, such as the IL product. SFL offer a full range of Gas Flue Boxes to suit most appliance types such as radiant gas fire conforming with BS7977-1, gas fires/back boilers to BS7977-2 as well as most live fuel effect fires (ILFE/LFE). When selecting a suitable Flue Gas Box, reference regarding size and type must be taken from the appliance manufacturers installation instructions.

For further detailed information on SFL's extensive range of Gas Flue Boxes, please refer to the appropriate sales brochure.

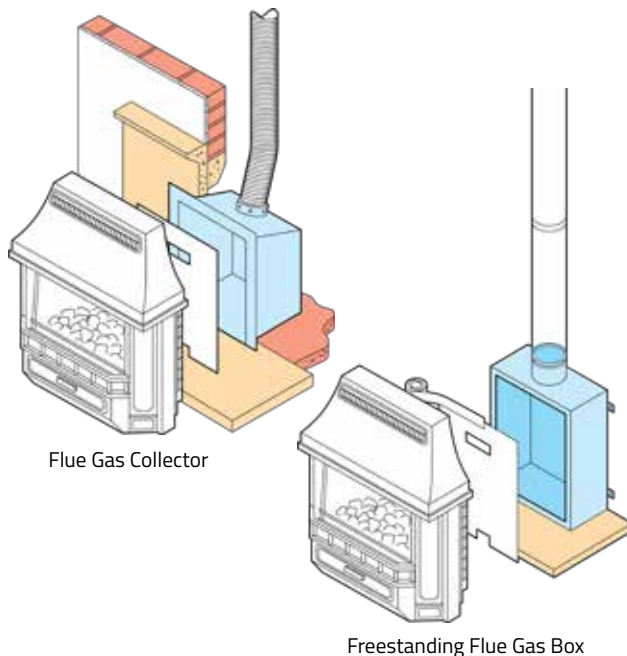

TYPICAL INSTALLATIONS

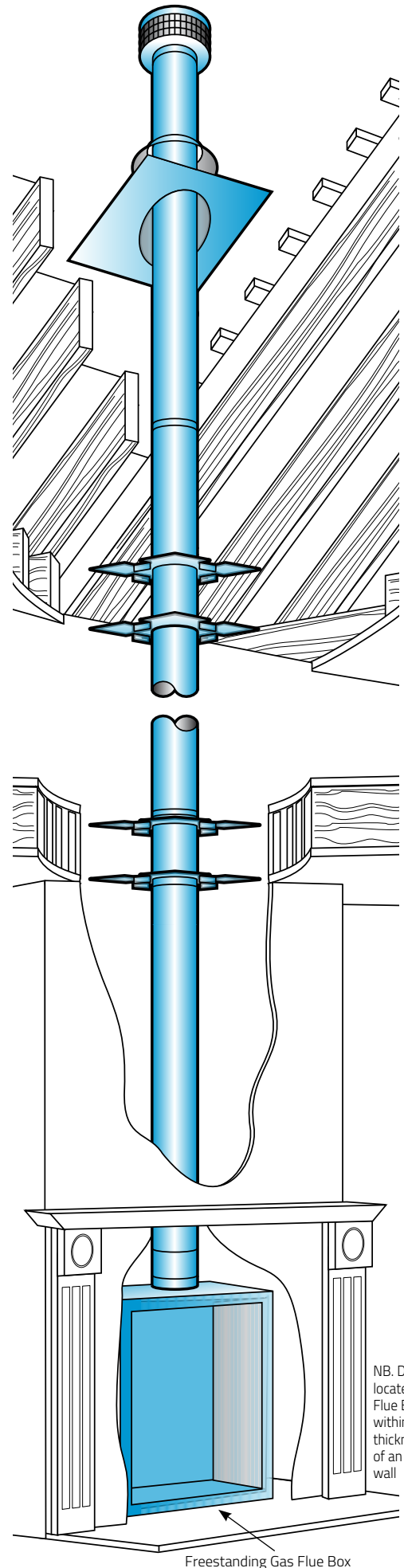

NB. Do not locate any Gas Flue Box within the thickness of an external wall

Freestanding Gas Flue Box

LENGTHS



Straight Lengths

Fixed straight lengths are available in five sizes: 152mm, 305mm, 457mm, 914mm and 1524mm (6in, 12in, 18in, 36in and 60in). Installed effective length is 38mm (1 1/2in) less than stated actual length.

152mm (6in) lengths

Size (mm)	Code number
125 5in	0421305
150 6in	0421306



305mm (12in) lengths

Size (mm)	Code number
125 5in	0421205
150 6in	0421206



457mm (18in) lengths

Size (mm)	Code number
125 5in	0421105
150 6in	0421106

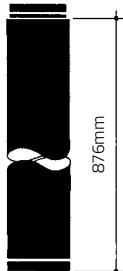

914mm (36in) lengths

Size (mm)	Code number
125 5in	0420305
150 6in	0420306

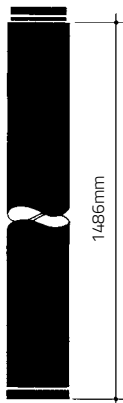

1524mm (60in) lengths

Size (mm)	Code number
125mm 5in	0420105
150mm 6in	0420106

Adjustable Lengths

Available in two sizes to ensure that an exact required vent length can be obtained.



305mm (12in) adjustable length

Size (mm)	Code number
125 5in	0421505
150 6in	0421506

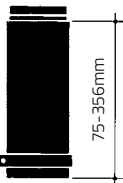

457mm (18in) adjustable length

Size (mm)	Code number
125 5in	0421605
150 6in	0421606

FITTINGS

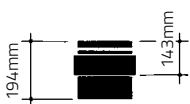

Draught Hood Connector

This component *must* be used to connect the system to an appliance spigot and also where the system is connected to a Transfer or Adaptor block for a BS EN 1858 Flue Block system. It cannot be used as a substitute for the Adaptor to Flue Liner.

Size (mm)	Code number
100 4in	0429304
125 5in	0429305
150 6in	0429306

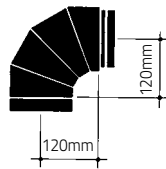

90° Adjustable Elbow

Provides variable angles or offset to be made but must not be used to exceed 45° from the vertical.

Size	Code number
125 5in	0422105
150 6in	0422106

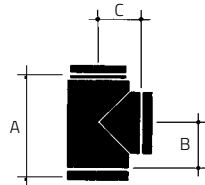

Equal Tee

A Tee cap is supplied.

Size (mm)	Dimensions	Code number
	A B C	
125 5in	241 96 102	0424305
150 6in	267 102 108	0424306

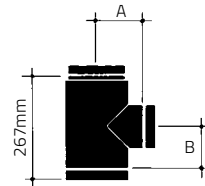

Reducing Tee

A Tee cap is available; it is not normally included unless specified.

Size (mm)	Dimensions	Code number
	Branch A B	
150 6in	125 5in 100	96 0425803

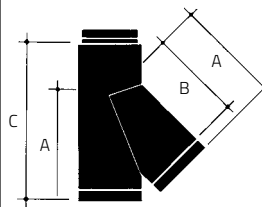

135° Tee

A Tee cap is supplied.

Size (mm)	Dimensions	Code number
	A B C	
125 5in	285 247 419	0424405
150 6in	315 277 419	0424406



Tee Cap

Size (mm) Code number

125 5in	0405305
150 6in	0405306



Disconnecter Section

Located immediately above the Appliance Connector, this component provides maintenance access without disturbing the flue system.

Size (mm)	Code number
125 5in	0420805
150 6in	0420806

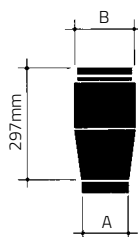

Increases

Size	Code number*
A B	
100mm x 125mm	4x5in 0428101
100mm x 150mm	4x6in 0428102
125mm x 150mm	5x6in 0428115

*size should also be specified when ordering

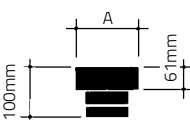

Adaptor to flexible flue liner

Lower end of this all aluminium component connects to standard product, upper end fits over fibre cement flue liner. Also used to connect to flexible flue liner.

Size (mm)	Dimension A	Code number
125 5in	144	0471605
150 6in	169	0471606

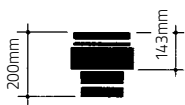

Flexible liner to IL Connector

Designed to be secured into the top of a stainless steel flexible flue liner at the point where the liner exits an existing masonry, or similar chimney. Connection would normally be in the roof space, and the IL Gas Vent continues to termination in the normal manner.

Size (mm)	Code number
125 5in	0421005
150 6in	0421006

FIXINGS & SUPPORTS

Support Plate

Used to support vents at floor penetrations in conjunction with the Support Flange (supplied).

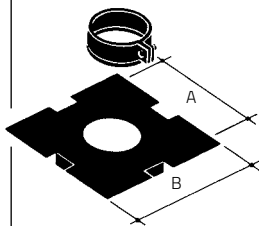

Size (mm)	Dimensions A* B**	Code number
125 5in	249 304	0403205
150 6in	270 304	0403206

*framing spacing
**overall size of square plate

Firestop Spacer

Used at floor or ceiling penetration or in conjunction with the Support Plate to maintain the required clearance to combustible materials.

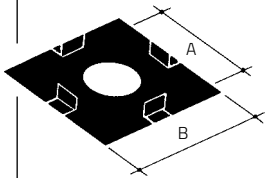

Size (mm)	Dimensions A* B**	Code number
125 5in	249 304	0408705
150 6in	270 304	0408706

*framing spacing
**overall size of square plate

Wall Band

Use at intervals not exceeding 3m to provide lateral support. If used externally, the galvanised component will require suitable weather protection.

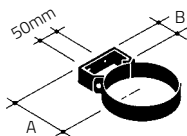

securing holes are 7mm diameter

Size (mm)	Dimensions A B	Code number
125 5in	126 56	0428805
150 6in	140 58	0428806

Stand-Off Wall Bracket

Made from galvanised steel, this component is designed to provide internal lateral bracing support off a wall or structure. The strut can be cut to length to provide variation in wall clearance.

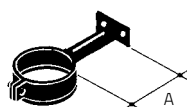

Size (mm)	Dimensions A max A min	Code number
125 5in	240 80	0429805
150 6in	237 80	0429806

FLASHINGS & TERMINALS

Note: Flashings and Storm Collars (with sealant supplied) must be ordered separately.

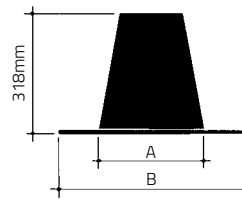

Tall-Cone Flat Flashing

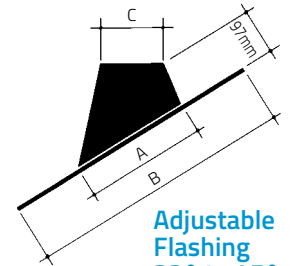

Adjustable Flashing 32° to 45°

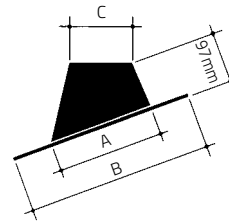

Adjustable Flashing 5° to 30°



Storm Collar

To find the appropriate component, combine the Family, Pitch and Identifier Codes to obtain the Part Order Code. Eg: Storm Collar for 125mm IL is 70-1234-03; Part Order Code is 70123403.

Family Code	Pitch Code	Identifier Code	Product	A	B (sq)	C (diam)
Storm Collar						
70	1234	03	125mm IL	-	-	-
70	1234	08	150mm IL	-	-	-
Flat Flashing						
70	0000	03	125mm IL	190	495	-
70	0000	08	150mm IL	279	495	-
5° - 30° Flashing						
70	0530	03	125mm IL	233	495	145
70	0530	08	150mm IL	279	495	171
32° - 45° Flashing						
70	3245	03	125mm IL	308	660	145
70	3245	08	150mm IL	362	660	171

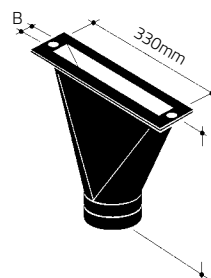

Ridge Tile Adaptor

Designed to be used with any approved ridge tile vent.

Size (mm)	Dimensions A B	Code number
Fabricated aluminium:		
125 5in	305 45	0401805

Gas Vent Terminal

Fabricated aluminium.

Size (mm)	Dimension A dia	Code number
125 5in	211	0407305
150 6in	238	0407306

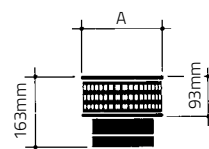

GENERAL

THE IL GAS VENT SYSTEM, WITH THE EXCEPTION OF THE DRAUGHTHOOD CONNECTOR AND THE ADJUSTABLE LENGTH, MUST NOT BE CUT, DRILLED OR ALTERED IN ANY WAY.

1 MANDATORY REQUIREMENTS

Connection to an appliance which is not connected to the fuel supply may be carried out by a competent person. However, connection to an appliance that is connected to the fuel supply MUST be carried out by a Gas Safe registered installer. The flue system must be installed to comply with Building Regulations Document J (England & Wales), Technical Booklet L (Northern Ireland) and Building Standards Technical Handbook 2020: domestic (Scotland). The installation also need to comply with BS5440: Part 1 for gas flues up to 60kW in the UK and IS183 in ROI.

2 LOCATION

IL has an aluminium liner and a galvanised steel outer skin, and can be applied both internally and externally. However, care should be taken to site the chimney so that it is not excessively cooled. BS5440: Part 1 requires a use of a stainless steel insulated flue on external runs exceeding 3 metres. In such cases either Nova or Sflue should be used for such applications. Any galvanised components used externally should be suitably weather protected.

3 FIXED FLUE SYSTEMS

Where IL is used to connect to a BS EN 1858 Gas Flue Block system, connection into the Transfer or Adaptor block must be made with a Draughthood Connector, and the joint thoroughly sealed with a suitable fire cement or high temperature silicone sealant. However, it is known that a badly constructed flue gas block system can result in a significant drop in flue gas temperature, such that condensation may occur. For that reason, where such systems are contemplated, it is advisable to ensure that the flue gas blocks have been correctly assembled, ie no leaks or projecting sealant/mortar into the flue way. Note that BS 5440: Part 1, prohibits the connection of some types of gas-fired appliance to gas flue block systems, unless they have been specifically assessed for such application. If in doubt, consult the appliance manufacturer, Gas Safe, or BS 5440: Part 1.

4 APPLICATION

A straight and vertical flue provides the most effective evacuation of the products of combustion. Whilst the IL Gas Vent System is extremely flexible, excessive changes of direction and angles greater than 45° from the vertical in any flue system must be avoided, as they will create considerable resistance to the movement of the flue gases. **HORIZONTAL RUNS MUST NOT BE USED** whatever the configuration. Always ensure that the first section of vent rises vertically from the appliance, (or the Flue Gas Box), a distance of not less than 600mm (2ft).

As a general rule, the vertical distance between the appliance and the flue terminal should always be twice the horizontal distance between the appliance and terminal. See Fig 1.

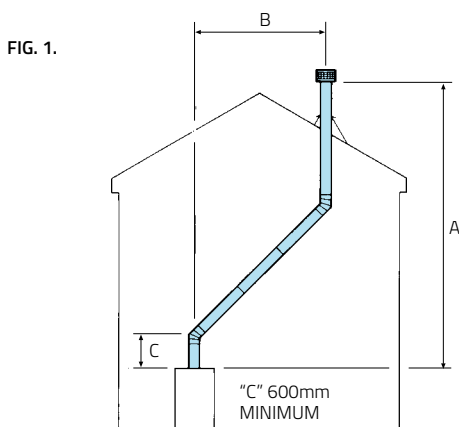

FIG. 1.

"A" should not be less than 2 x "B" or should be sized either in accordance with BS EN 13384-1/2, or the equivalent height data in BS 5440 Part 1.

5 CLEARANCE FROM COMBUSTIBLES

Support components provide a 50mm (2in) clearance from all combustible materials and this clearance MUST be maintained throughout the system.

6 JOINTING COMPONENTS

Vent pipe lengths and fittings must be installed with the male coupler upwards and female coupler downwards, fitting over the male. Make sure that the joining ends are round and undamaged, if any component is out of round, hand manipulation to correct the shape is recommended before attempting to fit the components.

To assemble the components, line up the three dimples on the male and female couplers, push the lengths together and turn to lock firmly. See Fig 2.

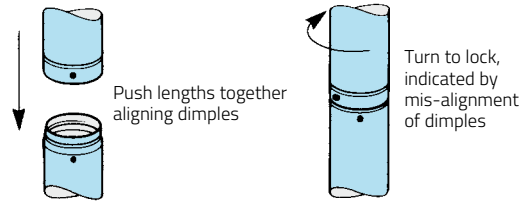

FIG. 2.

NB: For clarity the dimples are illustrated larger than actual size.

7 CONNECTING TO THE APPLIANCE

Always use a Draughthood Connector to connect the IL system to the appliance spigot or draughthood. The inner lining must be fitted inside, but NOT project below the spigot/outlet and can be cut to an appropriate length.

8 CONNECTING TO THE APPLIANCE – Gas Flue Boxes

Freestanding and Recessed Gas Flue Boxes accept a straight connection **WITHOUT A DRAUGHTHOOD CONNECTOR**. The Back Boiler Flue Box requires a Draughthood Connector to be attached to a straight length and passes through the hole in the top of the Box and into the boiler draughthood spigot. Both joints should be sealed with fire cement. **Handling** - The product is relatively easy to handle, but care should be taken when holding, fitting or assembling any part of the system. Users are advised to take suitable precautions, gloves etc., to avoid injury on any sharp exposed edges.

COMPONENT APPLICATION

9 DISCONNECTOR SECTION

This component may be used close to the appliance, preferably immediately above the Draught Hood Connector. Unclipping the lock band, will permit removal of the gas appliance without dismantling the remainder of the flue system.

10 ADJUSTABLE LENGTHS

These provide flexibility in the height or length of a vent run and allow for adjustment between two fixed points. Position the Adjustable Length over the top (male) of a straight length and adjust to the required dimension. Position the separate band towards end of the component and tighten the fixing.

11 TEES

These may be used at the base of the vent configuration, (with a Tee Cap in the base or branch), so as to provide access for inspection or cleaning.

12 ELBOWS

The Adjustable Elbow can be used to form variable angles and Fig 4 is for demonstration purposes as the elbow must not be used to set an angle of more than 45° measured from the vertical. Angles can be set by manipulating the segments. Elbows are usually used in pairs or singly to create an offset as shown.

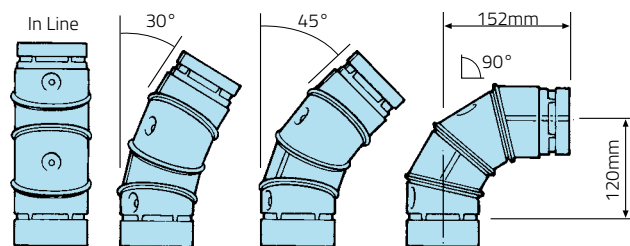

FIG. 3.

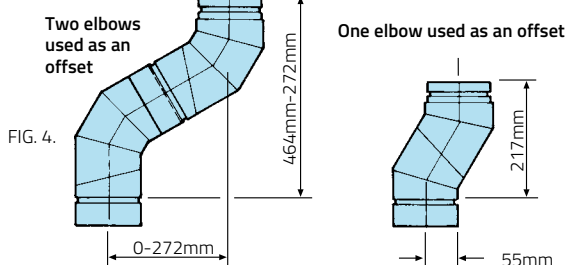

FIG. 4.

13 CEILING PENETRATION

Where the vent passes through a floor or ceiling without support, a Firestop Spacer must be used on both sides of the penetration to provide a barrier to fire and maintain a minimum 50mm (2in) air gap clearance to combustible materials. If the Gas Vent is required to be supported where it penetrates the floor/ceiling Support Plates should be applied. These square heavy gauge galvanised plates must be fixed through the corner holes on top of the floor joist or slab through which the chimney is passing. The flanged collar is clamped to the vent so that the lower flange rests on the support plate. A Firestop Spacer must be used on the underside of the opening at ceiling level. The *MAXIMUM* height that can be supported, including any suspended lengths, is 18m (60ft). The combination of lengths and fittings used should be such that no joint occurs within the floor space.

14 ADAPTOR TO FLEXIBLE FLUE LINER

This is a fitting for connecting an IL system to a flue liner. The adaptor makes a normal joint to the top (male) of the gas vent length. The flue liner then sits in the 60mm deep socket and is secured with self tapping screws (not provided). Seal the joint with fire cement.

15 WALL FIXING

In addition to structural support, the IL system *MUST* be secured with wall bands at intervals not exceeding 3m (10ft). Use fixings which ensure adequate attachment and support.

16 ROOF PENETRATION

The system must be braced with a Wall Band where it passes through the roof line.

Three Flashings are available for flat and pitched roofs. Tall Cone (for flat), and 5°-30° and 32°-45° (for pitched). Position the flashing over the projecting IL, and flash to the tiles or slates as appropriate. Fix the Storm Collar over the Flashing and seal the joint with the silicone sealant provided.

17 TERMINATIONS

Two methods of terminating an IL system are available:

Gas Vent Terminal. An aluminium terminal/cap, with a perforated sheet metal bird screen, which allows rapid exhaust of combustion products.

18 Ridge Tile Adaptor Used to adapt the vent to the rectangular opening or Ridge Tile Vents which exhaust the combustion products only at the apex of the roof. Separate instructions are provided with this component. See Fig 5.

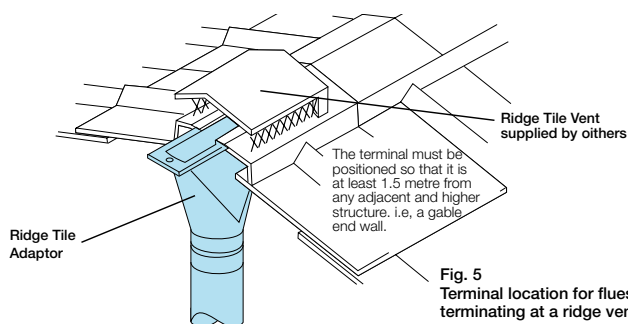

Fig. 5 Terminal location for flues terminating at a ridge vent.

19 TERMINAL LOCATION

Terminals should be sited to allow the products of combustion to disperse freely at all times.

To avoid adverse wind or pressure effects which might impede vent flow, the termination must be correctly located in relation to the roof and any nearby structures. Building Regulations, via BS 5440 Part 1, stipulate the legal requirements shown in Figs 5 to 8. NB A ridge tile vent terminal must be positioned so that it is not less than 1.5m from any adjacent structure. i.e. the gable end wall of an adjacent and higher dwelling. See Fig 5.

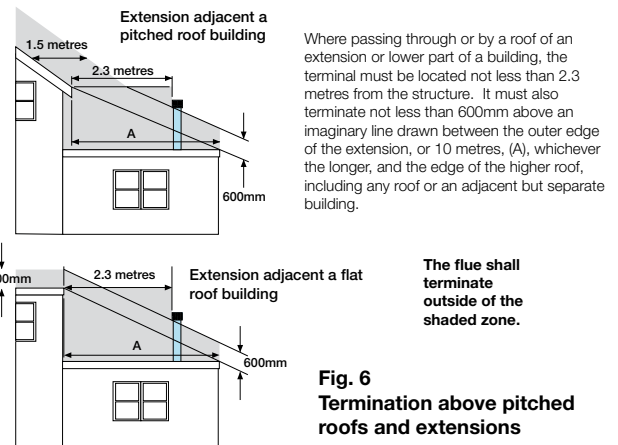
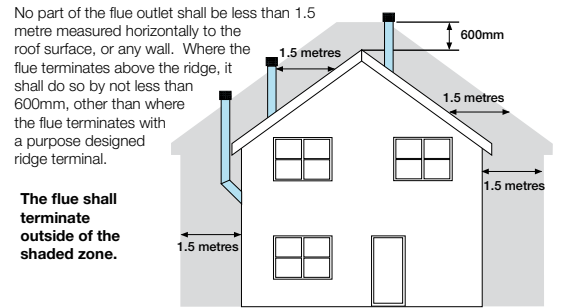

Fig. 6 Termination above pitched roofs and extensions

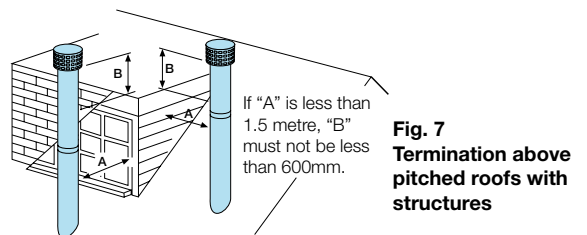

Fig. 7 Termination above pitched roofs with structures

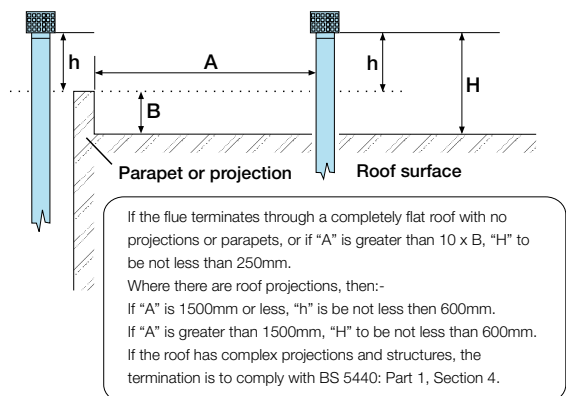

Fig. 8 Termination above a flat roof with structures

NB. Where the system extends more than 1m, but no more than 1.5m above the last support, (excluding the terminal), joints must be braced with a Joint Support Band, Product Code 04289. If it extends more than 1.5 metres, the extension above that level must also be braced with rigid stays.

20 AFTER INSTALLATION - TESTING & MAINTENANCE

Before operation, the integrity of the installed system should be tested by means of a flue flow test as described in BS EN 15287-1 with respect to the appropriate appliance type. Additional guidance on flow testing can be found in Appendix E of Approved Document J of the UK Building Regulations as well as BE 5440 Part 1.

It is essential that during the routine maintenance of the appliance, the venting system is also inspected. During this time the integrity of the venting system should be fully checked to ensure that the flue way remains clear and the integrity of the venting system is in good repair and sound.

About Us

Since 1969 we have provided expertise in system design and innovation for commercial, domestic and industrial applications, with uncompromised customer service. Our portfolio of trusted brands are known throughout the world for their engineering excellence.

We are proud of our British built heritage at SFL. All our products are fabricated at our manufacturing centre in Barnstaple, Devon, UK. As well as investment in the latest manufacturing system, we also have an extensive R&D centre ensuring continuous product development and testing to the latest European Standards.

Our Brands

SFL branded products are synonymous with the highest quality – it is this reputation that enables specifiers, contractors and house-holders to use our products with total confidence.



Get in touch

Head Office & Manufacturing Facility

SFL Flues & Chimneys
Pottington Business Park
Barnstaple
Devon
EX31 1LZ

Tel: +44 (0) 1271 326633
Email: info@sflchimneys.com
Web: www.sflchimneys.com



SFL pursues a policy of continuous improvement in both design and performance of its products and therefore reserves the right to change, amend or vary specifications without notice. Whilst the details contained herein are believed to be correct they do not form the basis of any contract and interested parties should contact the Company to confirm whether any material alterations have been made since publication of this brochure.